



NIPPEN
driven by values

NIPPEN ELECTRICAL INSTRUMENTS CO.

Digital Panel Meters • Energy Meters • Multifunction Meters • Power Factor Controllers
Protection Relays • Current Transformers • Insulation & Earth Testers • Iot Gateways

INDEX

• Digital Panel Meters	3-4
• VAF Meters	5
• Energy Meters	6-7
• Multifunction Meters	8-9
• Smart Load Managers	10
• Power Factor Controllers	11-12
• Earth Leakage Relays	13
• Line Monitoring Relays	14
• Voltage Monitoring Relays	15
• Current Monitoring Relays	16
• Analog Meters	17
• Current Transformers	18-19
• Insulation Testers	20-21
• Earth Testers	22
• Advanced Static VAr Generator (A-SVG)	23
• Active Harmonic Filter (AHF)	24
• Smart Net Real Time System	25-27
• IoT Gateways	28
• Ordering Information	29-31

DIGITAL PANEL METERS



Models	DV 1	DA 1	V DC	Hz	A DC (75mV)
Features	<ul style="list-style-type: none"> • True RMS • 1Ø-2W 	<ul style="list-style-type: none"> • True RMS • 1Ø-2W 	<ul style="list-style-type: none"> • DC VOLTS • 1Ø-2W 	<ul style="list-style-type: none"> • True RMS • 1Ø-2W 	<ul style="list-style-type: none"> • DC Ammeter • 1Ø-2W
Display	Red 7 Segment LED				
Digits Displayed	1 row of 4 Digits				
Electrical Connection	1Ø-2W Connection				
Input Range	19V-600V AC (L-L)	50mA-5A AC(20A max*)	1V -500V DC	40 to 99 Hz	Selectable current
CT Primary		1A /5A to 5000A AC			5000A -75mV DC
Aux.Supply	230V AC+/-20% (50/60 Hz), 80V- 270V AC/DC*				
Measuring Parameter	Voltage (L-N or L-L)	Current I1	DC Voltage	Frequency	Milli Volts 4-20mA DC(Selectable)*
Accuracy	Class 1				

* This indication valid for special model while ordering.



Models	DW 34	DPF 34	DA1(72x72)	DV1(72x72)	DA1/DV1 (72x72)
Features	<ul style="list-style-type: none"> • True RMS • 1Ø-2W 				
Display	Red 7 segment LED		Red 7 segment LED		
Digit Displayed	1 row of 4 Digits		1 row of 3 Digits		2 row of 3 Digits
Electrical Connection	1Ø-2W, 3Ø-4W		1Ø-2Wire		
Input Range	19V-600V AC (L-L), 50 mA - 5A(6A Max)		1A or 5A	500V AC	500V AC (L-L), 1A or 5A
CT Primary	1A /5A to 5000A AC		1A/5A to 999A AC		1A/5A to 999A AC
Aux.Supply	230V AC+/-20% (50/60 Hz), 80V- 270V AC/DC		230V AC±20% (50/60Hz), 80V-270V AC/DC*		
Measuring Parameter	Active power	Power Factor	Current I1	Voltage (L-N, L-L)	Voltage (L-N, L-L), Current I1
Accuracy	Class 1		Class 1		

Terminal Connections

Note: All New Products are available after 1st quarter 2023

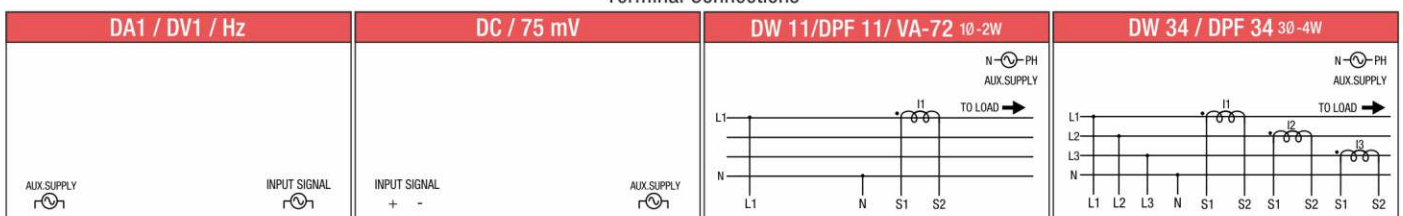

DIGITAL PANEL METERS



Models	DV3 / DV33	DA3 / DA33
Features	<ul style="list-style-type: none"> • True RMS • 3Ø-4W • 3 Row Display 	<ul style="list-style-type: none"> • True RMS • 3Ø-4W • 3 Row Display
Display	Red 7 Segment LED	
Digits	1 row of 4 digits, 3 rows of 4 digits*	
Electrical Connection	1Ø-2W, 3Ø-3W, 3Ø-4W	
Input Range	11-300V AC (L-N), 19-520V AC (L-L), 50 Hz	50mA -5A (6A max)
CT Primary		1A / 5A to 5000A
CT Secondary		1A or 5A (Factory Set)
PT Primary	100V-500kV (Factory Set)	
PT Secondary	100V-500V L-L (Factory Set)	
Aux. Supply	230V AC +/-20% (50 - 60Hz), 80 - 270V AC/DC*	
Measuring Parameter	Voltage (L-L, L-N) (Individual / Average)	Current I1, I2, I3 (Individual / Average)
Accuracy	Class 1	

Terminal Connections

* This indication valid for special model while ordering.

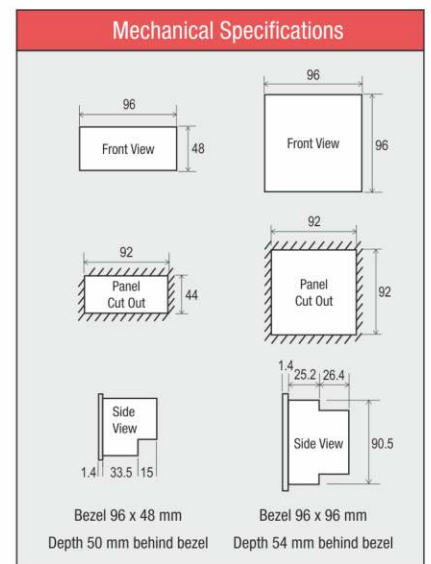
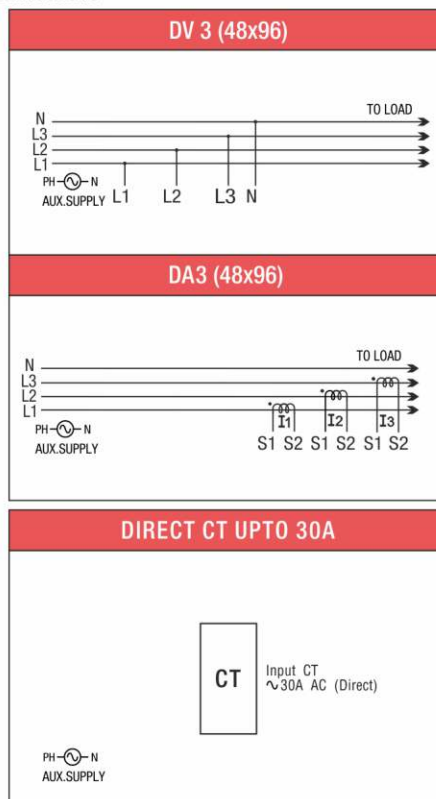
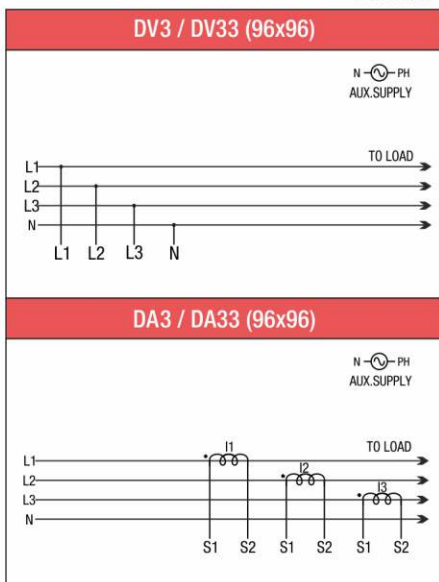

VAF METERS



Models	DT-36M	DT-36L	DT-36(48x96)
Features	<ul style="list-style-type: none"> Volt / Amps /Hz True RMS ON Hour/RPM Display Auto Scroll 	<ul style="list-style-type: none"> Volt / Amps / Hz True RMS ON Hour/RPM Display 	<ul style="list-style-type: none"> Volt / Amps /Hz True RMS ON Hour/ RPM Auto Scroll
Display	Red 7 Segment LED		
Digits	3 rows of 4 digits	3 rows of 3 digits	1 row of 4 digits
Electrical Connection	1Ø-2W, 3Ø-4W		
Input Voltage	11-300V AC(L-N), 19-520V AC(L-L), 50 Hz (max 65 Hz)		
Input Current	50mA -5A (6A max)		
CT Primary	1A /5A to 5000A	5A to 5000A	1A /5A to 5000A
CT Secondary	1A or 5A	5A	1A or 5A
PT Primary	100V-500kV (Factory Set)*		100V-500kV (Factory Set)*
PT Secondary	100V-500VL-L (Factory Set)*		100V-500VL-L*
Aux. Supply	230V AC +/-20% (50 - 60 Hz), 80 - 270V AC/DC*		
Measuring Parameter	Voltage (L-L,L-N) (Individual / Average), Current I1,I2,I3 (Individual / Average), Frequency, ON hours, Rpm	Voltage (L-L,L-N) (Individual / Average), Current I1,I2,I3 (Individual / Average), Frequency, ON hours, Rpm	Voltage (L-L, L-N) (Individual / Average), Current I1,I2,I3 (Individual / Average), Frequency, ON hours, Rpm
Accuracy	Class 1		

Terminal Connections

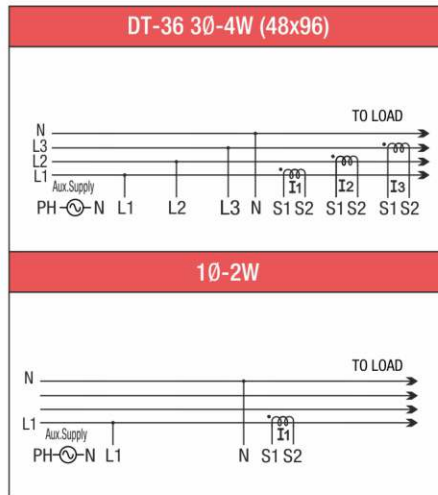
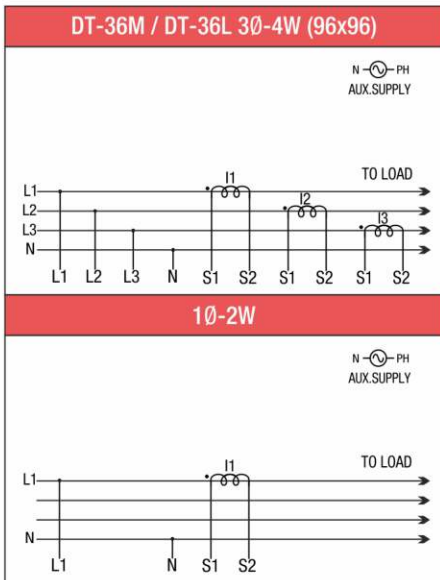

* This indication valid for special model while ordering.

Mechanical Specifications

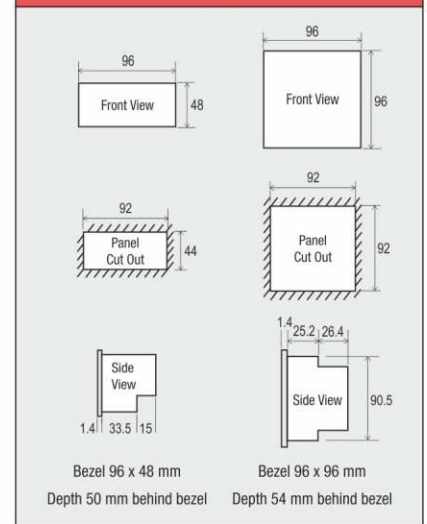

ENERGY METERS



Model (Size)	EM-3010	EM-3010VA	EM-3013
Features	<ul style="list-style-type: none"> 3Ø Energy (Active) EB or EB/DG (Dual) Old EB or EB/DG Energy Reading Pulse output 	<ul style="list-style-type: none"> 3Ø (Volts, Amps, Hz) 3Ø Energy (Active) EB or EB/DG (Dual) Old EB or EB/DG Energy Reading Pulse output 	<ul style="list-style-type: none"> 3Ø (Volts, Amps, Hz, PF) 3Ø Power (Active, Reactive, Apparent) 3Ø Energy (Active, Apparent) EB or EB/DG (Dual) Old EB or EB/DG Energy Reading Pulse output
Display	Red 7 segment LED display		
Digits	1 Rows of 6 digits		
Electrical Connection	1Ø-2W, 3Ø-3W, 3Ø-4W		
Input Voltage	11-300V AC(L-N), 19-520V AC(L-L), 50 Hz		
Input Current	20mA -5A (6A max)		
Resolution	0.01k, 0.1k, 1k, 0.01M, 0.1M, 1M (Depending upon CT Ratio x PT Ratio)		
CT primary	1A /5A to 5000A AC		
CT Secondary	1A or 5A		
PT Primary	100V- 500kV AC		
PT Secondary	100V- 500V(L-L) AC		
Aux. Supply	80V-270V AC/DC (50/60Hz)		
Measuring Parameter	Active Energy kWh	Voltage(L-L,L-N) (Individual / Average), Current I1,I2,I3 (Individual / Average), Frequency (Individual / Average), Active Energy kWh (Total)	Voltage(L-L,L-N) (Individual/Average), Current I1,I2,I3 (Individual / Average), Power Factor(Individual / Average) Frequency(Individual / Average), Active, Reactive,Apparent Power(Individual / Total), Active,Apparent Energy (Total)
Optional	RS485 MODBUS RTU protocol, Pulse output, WIFI*, GPRS*, Ethernet*,Direct inbuilt CT upto 60A*		
Accuracy	Active Energy (kWh): 1%	Amp: 0.5% Voltage (L-N & L-L): 0.5% Hz: 0.2% Active Energy (kWh): 1%	Amp: 0.5% Voltage (L-N & L-L): 0.5% Hz: 0.2% Active power (kW): 1% Reactive power(KVAr): 1% Apparent power (KVA): 1% Active Energy (KWh): 1% Apparent Energy (kVAh): 1%

Terminal Connections

* This indication valid for special model while ordering.

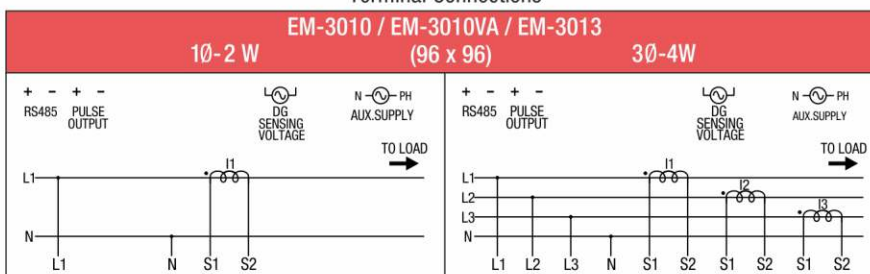

ENERGY METERS



Model (Size)	EM-3060	EM-3060 VA	EM-3063	EM-34
Features	<ul style="list-style-type: none"> • 3Ø Energy (Active) • Potential Free Pulse Output For Energy • EB or EB/DG (dual) Models • Old EB or EB/DG Energy Reading 	<ul style="list-style-type: none"> • 3Ø (Volts/Amps/Energy)(Active) • Potential Free Pulse Output For Energy • EB or EB/DG (dual) Models • Old EB or EB/DG Energy Reading • Auto scroll 	<ul style="list-style-type: none"> • 3Ø (Volts/Amps/Hz) • 3Ø Power (Active/Reactive/Apparent) • 3Ø Energy (Active/Apparent) • Potential Free Pulse Output • EB or EB/DG (Dual) Models • Old EB or EB/DG Energy Reading • Auto scroll 	<ul style="list-style-type: none"> • 6½ digit mechanical counter • Self Powered (100 to 550V-L) • Pulse output
Display	7 Segment LCD display with backlight			Mechanical counter
Digits	1 row of 12 digits for energy			1 row of 6½ digits for energy
Electrical Connection	1Ø-2W, 3Ø-3W, 3Ø-4W			
Input Voltage	11-300V AC (L-N), 19-520V AC(L-L), 50 Hz (max 65 Hz)			
Input Current	50mA - 5A (6A max)			
Resolution	For energy - 0.01k, 0.1k, 0.01M, 1M (Depending upon CT Ratio x PT Ratio)			For energy- 0.01k, 0.1k, 1k, 10k (Manual Shift)
CT Primary	1A /5A to 5000A			5A to 5000A
CT Secondary	1A or 5A			5A
PT Primary	100V-500kV		100V-500kV	
PT Secondary	100V-500VL-L			Self powered
Aux. Supply	230V AC +/-20% (50 / 60 Hz), 80 - 270V AC/DC*			Active energy (Total, EB & DG)
Measuring Parameter	Active energy (kWh) (Total EB&DG)	Voltage(L-L,L-N) (Individual/Average) Current I1,I2,I3 (Individual / Average) Active energy (kWh) (Total EB&DG)	Voltage(L-L,L-N) (Individual/Average) Current I1,I2,I3 (Individual / average), Frequency, Power Factor (Individual / Average), Active, Reactive, Apparent power (Individual / total) Active, Apparent energy (Total, EB, DG)	Active energy (kWh) (Total EB&DG)
Optional	Rs485 MODBUS RTU protocol, Pulse output, WIFI*, GPRS*, Ethernet*, Direct inbuilt CT upto 60A*			Pulse output 3200 pulses per kWh
Accuracy	Class 1			

Terminal Connections

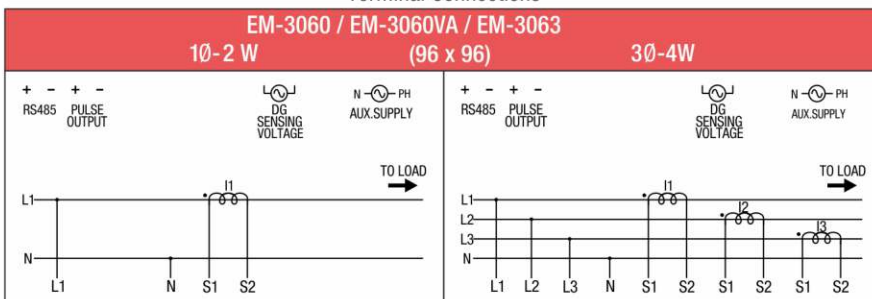

* This indication valid for special model while ordering.

Mechanical Specifications

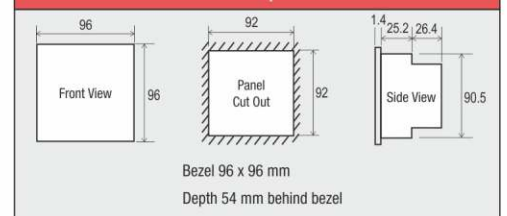

MULTIFUNCTION METERS



Models	DT-3600	DT-108	DT-108+
Features	<ul style="list-style-type: none"> 3\emptyset (Volts / Amps / PF / Hz) 3\emptyset Power (Active / Reactive / Apparent) ON Hours / Auxiliary Interrupt / RPM Auto Scroll 	<ul style="list-style-type: none"> 3\emptyset (Volts / Amps / PF / Hz) 3\emptyset Power (Active / Reactive / Apparent) 3\emptyset Energy (Active / Apparent) ON Hours / Auxiliary Interrupt / RPM Auto Scroll 	<ul style="list-style-type: none"> 3\emptyset (Volts / Amps / PF / Hz) 3\emptyset Power (Active / Reactive / Apparent) 3\emptyset Energy (Active / Apparent) Maximum / Minimum value Current Demand ON Hours / Auxiliary Interrupt / RPM THD upto 31st Harmonic Auto Scroll
Display	Red 7 segment LED		
Digits	3 rows of 4 digits and 8 digits for Energy		
Electrical Connection	1 \emptyset -2W, 3 \emptyset -3W, 3 \emptyset -4W		
Input Voltage	11-300V AC (L-N), 19-520V AC, (L-L), 50 Hz (max 65 Hz)		
Input Current	20 mA - 5A (6A max)		
Resolution	For energy: 0.01k, 0.1k, 1k, 0.01M, 0.1M, 1 M / 1000 pulses per kWh		
CT Primary	1A / 5A to 5000A (Programmable for any value)		
CT Secondary	1A or 5A		
PT Primary	100V-500kV (Programmable for any value)		
PT Secondary	100V-500V L-L (Programmable for any value)		
Aux. Supply	230V AC +/-20% (50 / 60 Hz), 80 - 270V AC/DC*		
Measuring Parameter	Voltage (L-L,L-N) (Individual / Average), Current I1,I2,I3, (Individual /Average), Frequency, On hours, Rpm, Power factor (Individual /Average), Active, Reactive, Apparent power (Individual /total)	Voltage (L-L,L-N) (Individual /Average), Current I1,I2,I3, (Individual /Average), Frequency, On hours, Rpm, Power factor (Individual /Average), Active, Reactive, Apparent power (Individual /Total) Active, Apparent, Energy (EB Total)	Voltage (L-L,L-N)Individual / Average), Current I1,I2,I3 (Individual /Average), Frequency, Current demand, %THD, On hours, Rpm, Minimum, Maximum Value, PF(Individual /Average), Active, Reactive Apparent power (individual/Total) Active, Apparent energy (EB Total)
Optional	Active Energy DG RS485 communication Modbus RTU protocol, Single relay output, WIFI*, GPRS*, Ethernet*, Direct inbuilt CT upto 60A*		
Accuracy	Class 1		

Terminal Connections

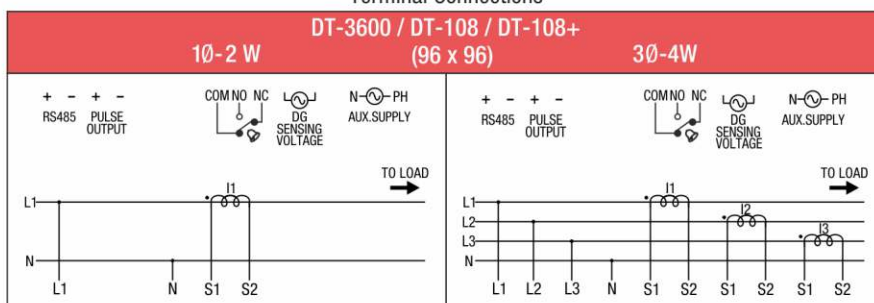

* This indication valid for special model while ordering.

Mechanical Specifications

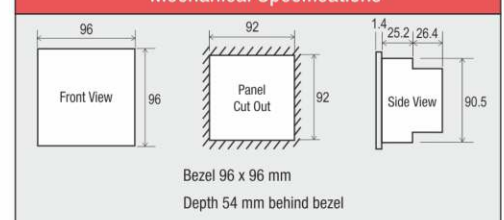

MULTIFUNCTION METERS

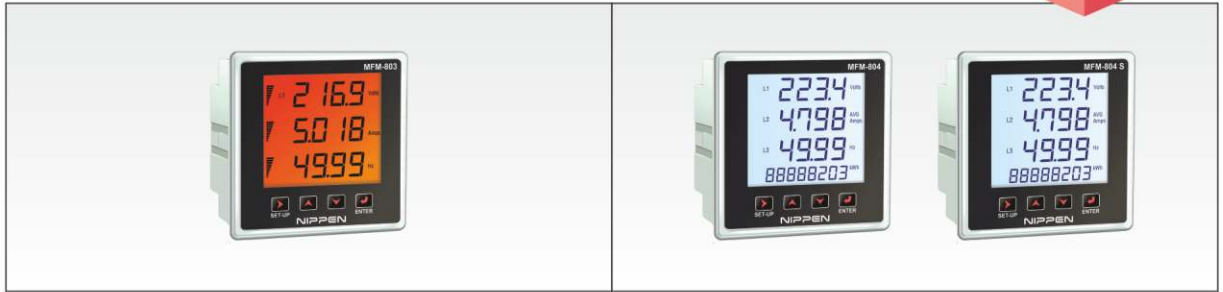

Models	MFM-803	MFM-804/ MFM-804S
Features	<ul style="list-style-type: none"> • 3 Row LCD display with BarGraph • 3Ø Power (Active, Reactive, Apparent) • Pulse output • Maximum /Minimum value, Demand • THD upto 31st Harmonic • Auto Scroll 	<ul style="list-style-type: none"> • 4 Row LCD display • 3Ø Power (Active, Reactive, Apparent) • 3Ø Energy (Active for MFM-804) • 3Ø Energy (Active, Reactive, Apparent- for MFM-804S) • Pulse output • Maximum /Minimum value, Demand • THD upto 31st Harmonic
Display	7 segment LCD with backlight	
Digits	3 Rows of 4 Digits, 8 Digits for Energy Bargraph Represents Current	3 Rows of 4 Digits, 1 Row of 8 digits for Energy
Electrical Connection	1Ø-2W, 3Ø-3W, 3Ø-4W	
Input Voltage	11-300V AC (L-N), 19-520V AC (L-L), 50Hz (max 65 Hz)	
Input current	50mA - 5A (6A max)	
Resolution	For Energy- 0.01k, 0.1k, 1k / 1000 pulses per kWh	
CT Primary	1A / 5A to 5000A	
CT Secondary	1A or 5A	
PT Primary	100V - 22kV	
PT Secondary	100V- 500 VL-L	
Aux. Supply	80 - 270V AC/DC (50 / 60 Hz)	
Measuring Parameter	Voltage (L-L,L-N) (Individual/Average), Current I1,I2,I3 (Individual/Average), Frequency, Current demand, %THD, Minimum, Maximum value (L-N,L-L,A,HZ), Power factor (Individual/Average), Active, Reactive, Apparent power (Individual /Total), Active, Reactive*, Apparent* Energy (Total) 3Ø Energy (Active for MFM-804) 3Ø Energy (Active, Reactive, Apparent for MFM-804S)	
Optional	RS485 communication Modbus RTU protocol *, Pulse output* Single relay output*, WIFI*, GPRS*, Ethernet*, Direct inbuilt CT upto 60A*	
Accuracy	Class1	Class1 (MFM-804) Class 0.5 (MFM-804S)

* This indication valid for special model while ordering.

Terminal Connections

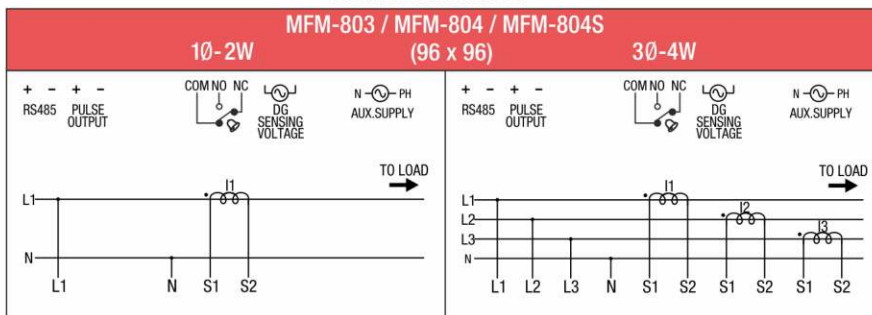

Mechanical Specifications

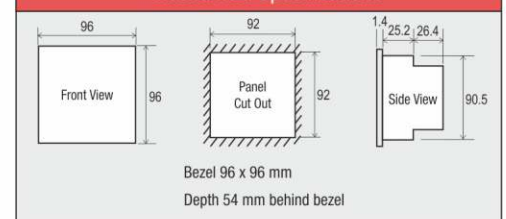

SMART LOAD MANAGERS



Model (Size)	SL-6300	SL-6300 MDC	SL-6300 DG
Features	<ul style="list-style-type: none"> 3Ø (Volts/ Amps / Hz / PF) 3Ø Power (Active/ Reactive/ Apparent) 3Ø Energy (Active/ Reactive/ Apparent) (4 Quadrant) % THD upto 31st Harmonic Maximum /Minimum Demand (Power) Accuracy 0.5% 	<ul style="list-style-type: none"> 3Ø (Volts/ Amps / Hz / PF) 3Ø Power (Active/ Reactive/ Apparent) 3Ø Energy (Active/ Reactive/ Apparent) (4 Quadrant) Controls Rising Demand (Active/Apparent) 2 Relay or 4 Relay output %THD upto 31st Harmonic Max /Min Demand (Power) Real Time Clock 	<ul style="list-style-type: none"> 3Ø (Volts / Amps/ Hz / PF) 3Ø Power (Active/ Reactive/ Apparent) 3Ø Energy (Active/ Reactive/ Apparent) (4 Quadrant) EB or EB/DG (Dual) %THD upto 31st Harmonic
Display	Red 7 segment LED display		
Digits	3 Rows of 4 digits		
Electrical Connection	1Ø-2W, 3Ø-3W, 3Ø-4W		
Input Voltage	11-300V AC(L-N), 19-520V AC(L-L), 50 Hz		
Input Current	20mA - 5A (6A max)		
Resolution	Power factor: 0.001 lead, lag		
CT Primary	1A /5A to 5000A		
CT Secondary	1A to 5A		
PT Primary	100V- 500kV AC		
PT Secondary	100V- 500V(L-L) AC		
Aux. Supply	80V-270V AC (50/60Hz)		
Measuring Parameter	Voltage (L-L,L-N) (Individual/ Average), Current I1,I2,I3 (Individual/ Average), Frequency, %THD, Demand, Power factor (Individual/ Average), Active, Reactive, Apparent power (Individual /Total), Active, Reactive, Apparent energy EB (DG for SL 6300 MDC) (Total, Export, Import), Min, Max value (L-N, L-L, A, Hz), Phase Sequence Detection, Run Hr., Load Hr.		Voltage(L-L,L-N) (Individual/Average), Current I1,I2,I3 (Individual/Average), Frequency, %THD, Demand, Power Factor (Individual/ Average) Active, Reactive, Apparent power (Individual/Total) Active, Reactive, Apparent energy EB, DG (Total, Exp,Imp) Min, Max value (L-N, L-L, A, Hz) Phase Seq. Detection, Run Hr., Load Hr.
Optional	RS485 communication Modbus RTU Protocol WIFI*, GPRS*, Ethernet*	RS485 communication Modbus RTU Protocol 4Relay output, WIFI*, GPRS*, Ethernet* Direct inbuilt CT upto 60A*	RS485 communication Modbus RTU Protocol WIFI*, GPRS*, Ethernet*
Accuracy	Class 0.5*		

Terminal Connections

* This indication valid for special model while ordering.

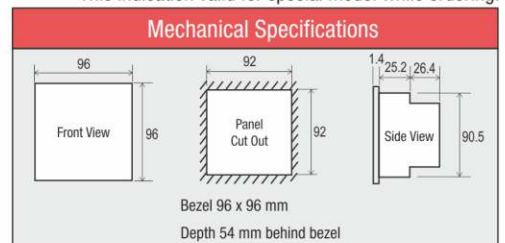
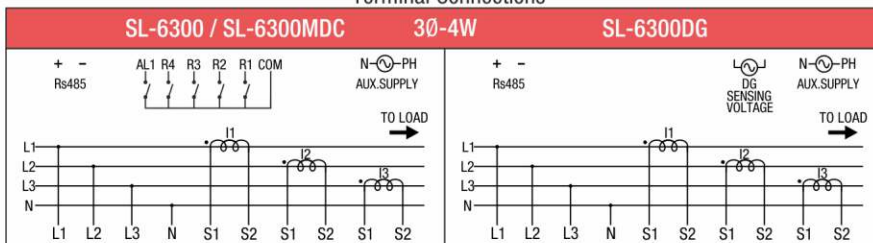

POWER FACTOR CONTROLLERS (SINGLE CT)



Model (Size)	APFC-414, APFC-414-1p	APFC-414-144, APFC-414-144-1p	APFC - PRO
Features	<ul style="list-style-type: none"> • Auto Detection of Capacitor values & Aging • kVAr sensing with sophisticated algorithm • Compact size upto 12 relay • CT Polarity auto detection • Under-compensation relay output* 	<ul style="list-style-type: none"> • Auto Detection of Capacitor values & Aging • kVAr sensing with sophisticated algorithm • Compact size upto 16 relay • CT Polarity auto detection • Under-compensation relay output* 	<ul style="list-style-type: none"> • Auto Detection of Capacitor values • kVAr sensing with sophisticated • No button / No user setting required
Display	Red 7 segment LED		
Digits	1 row of 4 digits		
Electrical Connection	1Ø-2W, 3Ø-4W		
Input Voltage	11-300V AC(L-N), 19-520V AC(L-L), 50 HZ		
Input Current	20mA - 5A(6A max)		
Resolution	For power factor- 0.001 Lead, Lag		
CT Primary	1A /5A to 5000A		
CT Secondary	1A or 5A (Factory Settable)		
PT Primary	100V -500kV		
PT Secondary	100V-500V L-L		
Aux. Supply	80V - 270V AC/DC (50 / 60 Hz)		
Measuring Parameter	Voltage (L-L), Current, Power factor (Average), Reactive Power (Total)		
Relay Stage	12 relay and 1 relay for under compensation	16 relay and 1 relay for under compensation	8 relay output
Accuracy	Class 1		

Terminal Connections

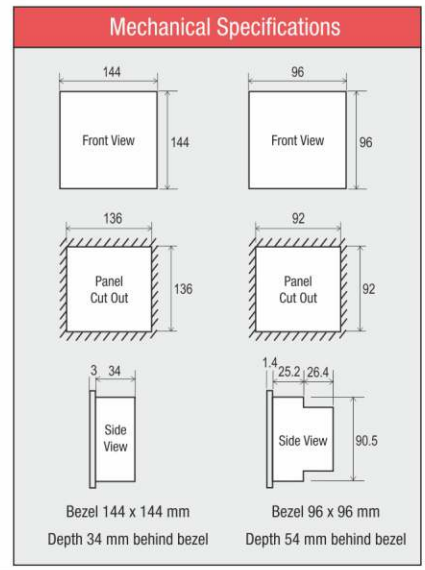
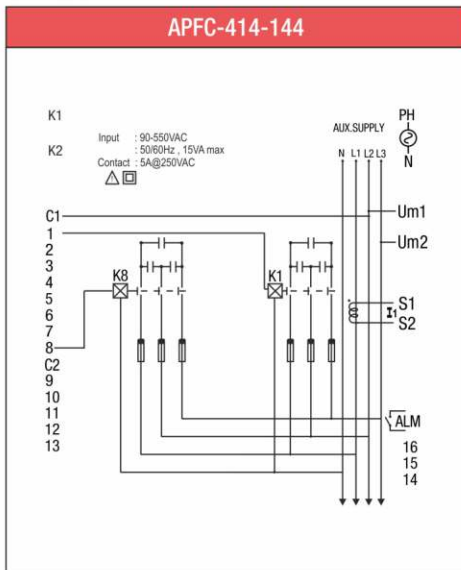
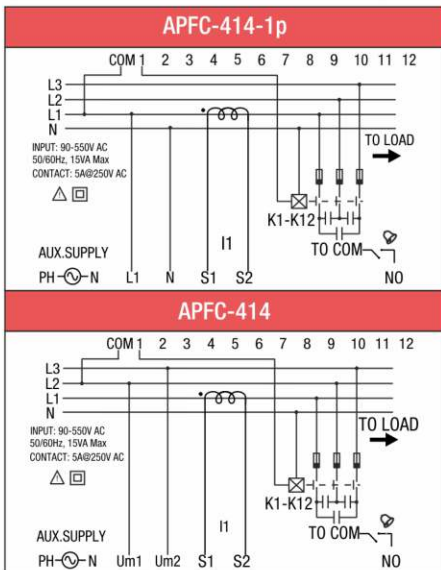

POWER FACTOR CONTROLLERS (3 CT)



Models	UNO-12R	UNO-36L-144	UNO-36L
Features	<ul style="list-style-type: none"> Built in MFM with PF Controller LED display Auto detection of capacitor bank values kVAr sensing with sophisticated algorithm Compact size upto 12 Relay and 2 Alarm CT Polarity auto detection 	<ul style="list-style-type: none"> Built in MFM with PF Controller LCD display Auto detection of capacitor bank values kVAr sensing with sophisticated algorithm Compact size upto 16 relay 	<ul style="list-style-type: none"> Built in MFM with PF Controller LCD display Auto detection of capacitor bank values kVAr sensing with sophisticated algorithm Compact size upto 12 Relay CT Polarity auto detection
Display	Red 7 segment LED	7 Segment LCD with backlight	
Digits	3 rows of 3 digits	3 rows of 4 digits, 3 1/2 digits for PF	
Electrical Connection	3Ø-4W		
Input Voltage	11-300V AC (L-N), 19-520V AC (L-L), 50Hz		
Input Current	20mA - 5A (6A max)		
Resolution	Power factor: -.01 lead, lag	Power factor: -1.000 lead, lag	
CT Primary	1A /5A to 5000A	1A /5A to 5000A	
CT Secondary	1A or 5A		
PT Primary	100V-500kV	100V - 22kV	
PT Secondary	100V - 500VL-L		
Aux.Supply	80 - 270V AC/DC (50 / 60 Hz)		
Measuring Parameter	Voltage (L-L, L-N) (Individual / Average), Current I1,I2,I3 (Individual / Average), Frequency, %THD 31 st Level, Power factor (Individual /Average), Active, Reactive, Apparent power (Individual /total),Active, Reactive, Apparent energy (Total) (For UNO12R only), MDC (For UNO36L-144 & UNO36L), Load Hour (For UNO12R only), Run Hour, Min Max value (L-N, L-L, A, Hz)*		
Relay Stage	12 relay and 2 alarm output for OV,UV, OA,UA,OHZ,UHz	16relay and 1 relay for under compensation	12 relay and 1 relay for under compensation
Optional	Rs485 communication Modbus RTU protocol, WIFI*, GPRS*, Ethernet*		
Accuracy	Class1		

Terminal Connections

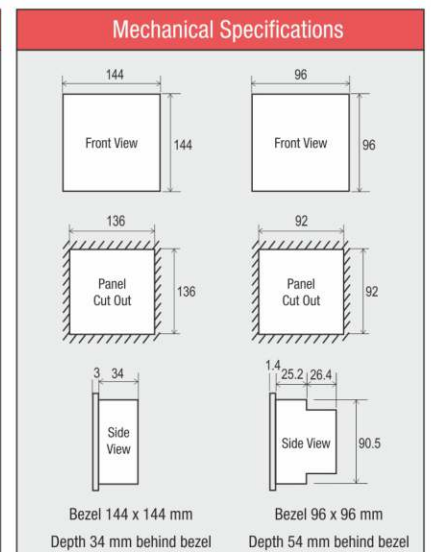
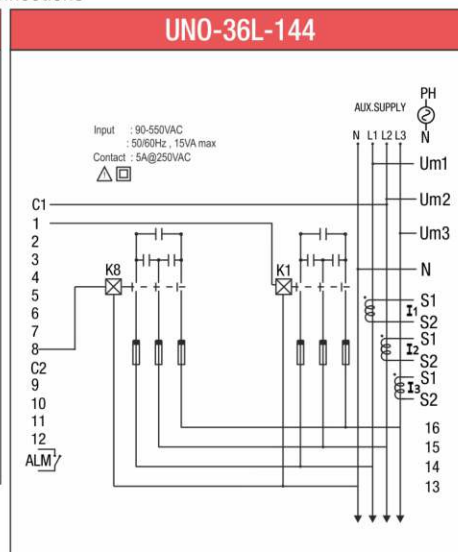
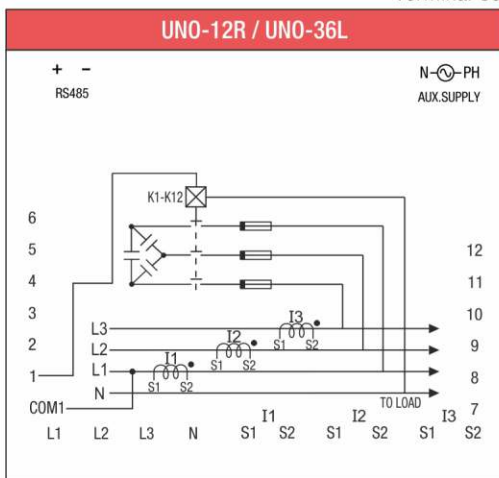

EARTH LEAKAGE RELAYS



Model (Size)	ELR (96X96)	DIN RAIL (45X90)
Features	<ul style="list-style-type: none"> Monitor True RMS Earth Leakage Current (upto 30A) Test and Reset Function Leakage Current and CBCT Open Indication Earth Leakage current in bargraph 	<ul style="list-style-type: none"> DIN Rail Mountable Monitor True RMS Earth Leakage Current (upto 30A) Leakage Current and CBCT Open Circuit Indication Earth Leakage current in bargraph
Display	Red 7 Segment LED	
Digits	3 digits	
Electrical Connection	CBCT secondary (Ratio 1000:1)	
Fail Safe Relay	>50% of set value	
Trip Relay	>75% of set value	
Relay Rating	8 Amps for trip relay, 3 Amps for Fail safe relay	
Leakage Current range	0.03, 0.1, 0.3, 0.5, 1, 3, 5, 10, 20, 30A	
Time Delay Range	0, 0.06, 0.15, 0.25, 0.5, 0.8, 1, 2.5, 5, 10 seconds	
Measuring Parameter	Leakage current, Bargraph, CBCT open circuit, Trip status	
CBCT	35mm, 70mm, 120mm, 210mm, 310mm*, Rectangular CBCT *	
Aux. Supply	230V AC +/-20% (50/60 Hz)	

Terminal Connections

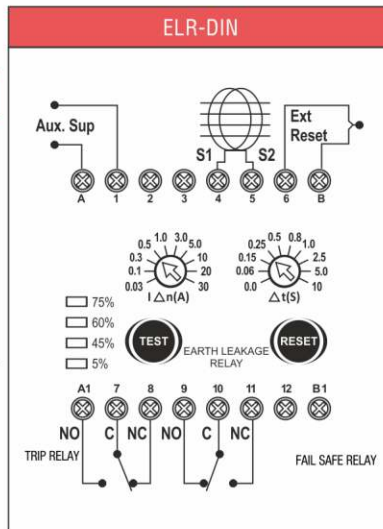
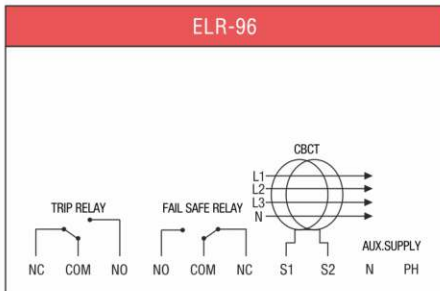

Mechanical Specifications

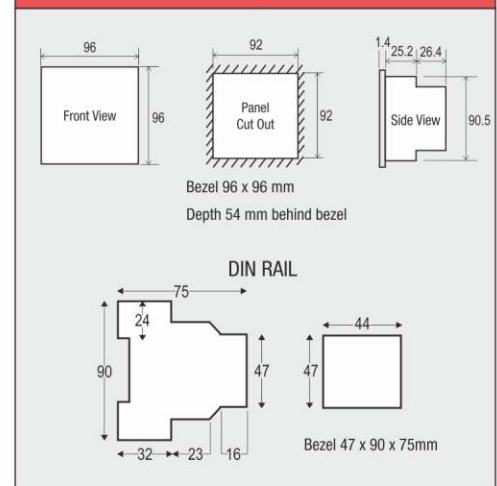

Ordering Information

DESCRIPTION	CBCT
CT Ratio	1000:1
Sizes (inner diameter)	35mm, 70mm, 120mm, 210mm, 310mm

Inner Diameter	Order Code
35mm	CBCT-35-1
70mm	CBCT-70-1
120mm	CBCT-120-1
210mm	CBCT-210-1
310mm	CBCT-310-1



LINE MONITORING RELAY



Model (size)	900UVR / 903UVR	Model (size)	500PSR	300LMR
Features	<ul style="list-style-type: none"> • Trip level 75% of Supply Voltage • ON Delay Time settable • Supply LED Indication 	Features	<ul style="list-style-type: none"> • Phase Sequence • LED indication: Power ON & Trip 	<ul style="list-style-type: none"> • Monitors Under & Over Voltage • Monitors Phase Failure & Sequence • LED indication : Power ON, Trip • Space saving design
Measurement	Under voltage	Modes	Phase sequence: Yes Reset: Auto reset on removal of fault condition	Phase failure : Yes Phase sequence : Yes Under voltage : 170 to 224V AC Over voltage : 236 to 290V AC
Alarm Indication	Trip	Accuracy	±1% of F.S.	Trip Voltage : ±0.5% of F.S. Trip Time : ±5% of F.S
Electrical Connection	1Ø-2W, 3Ø-4W	Time Ranges	Power ON Delay: 200msec	Trip time delay : 2.5 to 22.5s, Power On delay : 100msec
Trip Setting	Factory set 75% of supply voltage	Output Contact	1 C/O(SPDT)	1 C/O (SPDT)
Delay Time Setting	1-10 Min.	Output Rating	NO: 5A@250V AC, NC: 3A@250V AC	NO: 5A@250V AC / 30V DC NC : 3A@250V AC / 30V DC
Accuracy	± 5%	Electrical Connection	3Ø-3W	3Ø - 3W, 3Ø -4W*
Output Contact	1C/O DPDT	Operating Voltage	280 to 520V AC (L - L)	170 to 290V AC (L - L)
Relay Rating	5A/250V			
Supply Voltage	Self powered			
Frequency	48 - 63Hz			
Power Consume	5VA			
Dimensions	90(L) x 17.5(W) x 55(H)mm			

Terminal Connections

900UVR / 903UVR	500PSR	300LMR	Mechanical Specifications

Note: All New Products are available after 1st quarter 2023

VOLTAGE MONITORING RELAY



Model	300VPR-1	300VPR	600VPR
Features	<ul style="list-style-type: none"> Monitors Under & Over Voltage Monitors Phase Failure & Phase Sequence LED indication: Fault condition, L1,L2,L3 & Hz, Asy. Space saving design 	<ul style="list-style-type: none"> Monitors Under voltage, Over Voltage, Under Frequency, Over Frequency, Phase Asy, Phase loss, Phase Sequence, Neutral Loss.* One alarm output NO/NC LED indication: Fault condition, L1,L2,L3 & Hz, Asy. 	
Display	Red 7 segment LED		
Digit	3 Digit	3 Digit	
Measurements	Under & Over Voltage, Phase Failure & phase Sequence	Under/Over voltage, Under/ Over frequency, Phase asymmetry, Phase Loss Phase sequence, Neutral Loss*	
Electrical Connection	3Ø-3W	1Ø-2W, 3Ø-3W, 3Ø-4W (Selectable)	
Trip Setting		Under / Over voltage: 280 to 520V AC L-L, 160-280V AC L-N (for 3Ø-4W) Under / Over Frequency: 45/65Hz, Voltage Asymmetry: 5.0 to 99.9%	
Trip Time Setting	Trip time delay : 0 to 10 sec Power On Delay : <100msec	Power On Delay: 1 to 999 sec, Trip Time Delay: 0 to 999 sec, Recovery Time delay: 0 to 999 sec, Response Time : <100ms	
Hysteresis		Voltage: 1.0 to 99.9%, Frequency: 0.2- 2%, Asymmetry: 2- 20%	
Resolution		Voltage: 1V, Frequency: 0.1Hz	
Accuracy	Trip Voltage : $\pm 0.5\%$ of F.S Trip Time : $\pm 5\%$ of F.S	Voltage: $\pm 1\%$ of set value, Frequency: $\pm 0.3\text{Hz}$, Time(Recovery time, Trip delay, Power ON delay): $\pm 5\%$ of setting $\pm 100\text{ms}$	
Output Contact	1 C/O (SPDT)	1 C/O (SPDT)	
Output Rating	NO: 5A@250V AC, NC: 3A@250V AC	NO: 5A@250V AC, NC: 3A@250V AC	
Supply Voltage	Self powered (310 to 520V AC (L - L))	160V to 280V AC (50/60Hz)	
Alarm Indication	Trip		

Terminal Connections

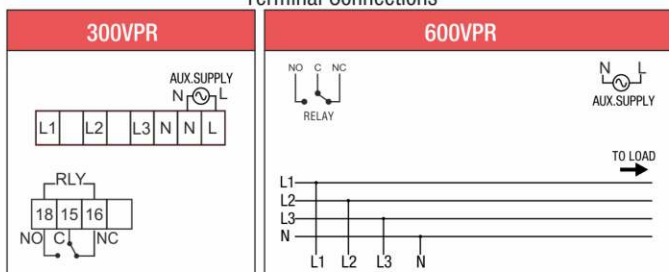

Mechanical Specifications

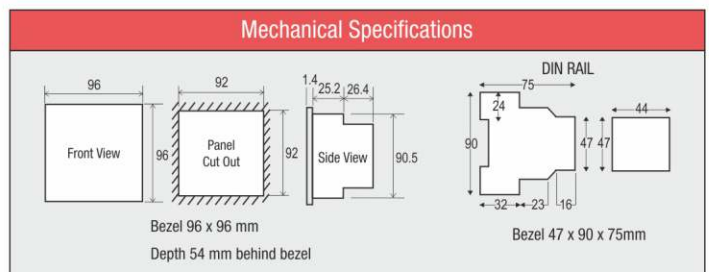

Note: All New Products are available after 1st quarter 2023

CURRENT MONITORING RELAYS



Model	300CPR-1	300CPR	600CPR
Features	<ul style="list-style-type: none"> Monitors Under, Over Current One alarm relay with NC or NO LED Indication: Fault condition, I1, Asy. 	<ul style="list-style-type: none"> Monitors under current & over current, current Asy. One Alarm relay with NC or NO LED Indication: Fault condition, I1,I2,I3, Asy. Auto / Manual reset function Selectable individual trip time setting for every fault 	
Display	Red 7 Segment LED		
Digit	3 Digit		
Measurements	Under Current, Over Current, Current Asy.		
Electrical Connection	1Ø-2W	1Ø-2W, 3Ø-3W, 3Ø-4W	
CT Setting	CT Primary: 1 to 999A, CT Secondary: 5A	CT Primary: 1 to 999A, CT Secondary: 5A	
Trip Setting	Under Current: 0-999A Over current: 0-999A.	Under Current: 0 to 999A Over current: 0 to 999kA Current asy: 10-99.9%	
Trip Time Setting	Power ON Delay: 1-999 sec, Trip time Delay: 0-999 sec, Recovery time Delay: 0-999 sec, Response Time: <100ms		
Hysteresis	Current 0.1 to 99.9%		
Accuracy	Current : ±1%, Time (Recovery time, Trip delay, Power ON Delay): ±5% of setting ± 100ms		
Output Contact	1 C/O (SPDT)		
Output Rating	NO: 5A@250V AC, NC: 3A@250V AC		
Supply Voltage	160V to 280V AC/DC	160V to 280V AC (50/60Hz)	
Alaram Indication	Trip		

Terminal Connections

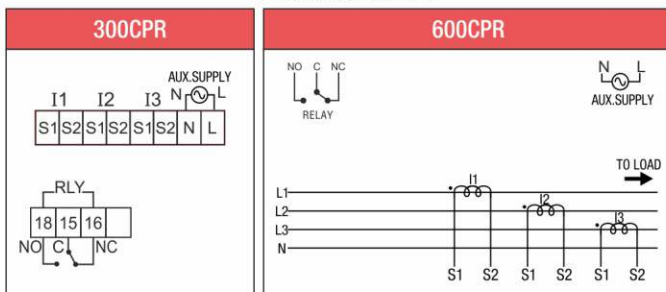

Mechanical Specifications

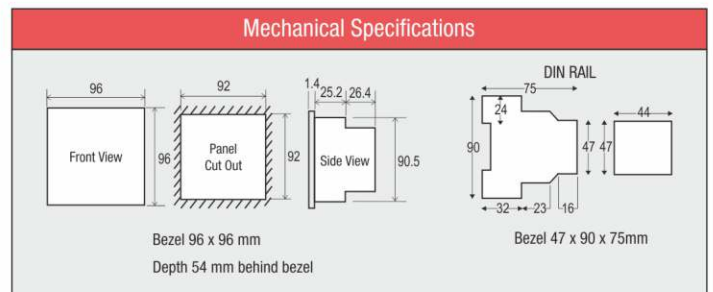

Note: All New Products are available after 1st quarter 2023

ANALOG METERS (AC & DC)

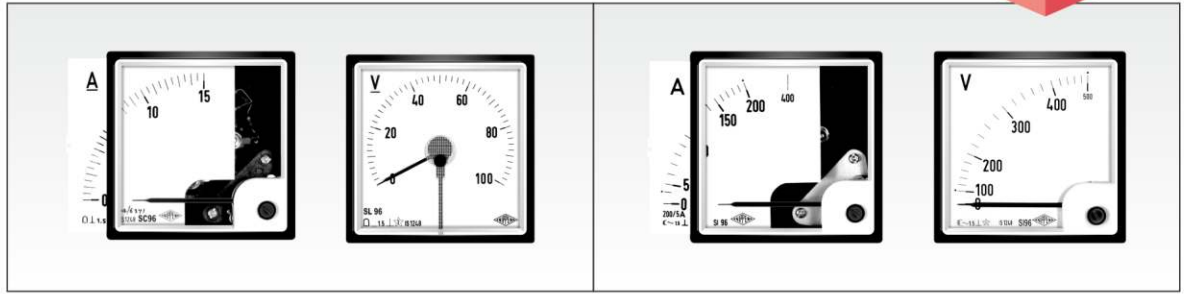

Models	MOVING COIL METERS	MOVING IRON METERS
Features	<ul style="list-style-type: none"> • High coercive magnetic circuit • Spring back sapphire jewels • High Torque / Weight ratio • Critically damped movement • Highly linear dial pattern • Self shielded movement • Angle of deflection 90° and 240° • Type-tested at ERTL 	<ul style="list-style-type: none"> • Scale interchangeability • Oil damped movement with recessed jewels • Spring back sapphire jewels to neutralize shock & vibration • Very high torque to weight ratio • Shielded movement • Totally consistent scale pattern • Type-tested at ERTL
Sizes	48x48mm, 72x72mm, 96x96mm, 144x144mm	
Measuring Voltage Range	Upto 500V (AC & DC)	
Measuring Current Range	5A upto 100A direct (AC), C.T. range upto 5000A AC 5A upto 30A direct (DC), Shunt range upto 5000A/75mV DC	
Operating Temperature	-10°C to + 55°C RH 90 %	
Storage Temperature	-20°C to + 70°C RH 90 %	
Pointers	Construction in accordance with DIN 43802	
Marking	Adheres to IEC- 51	
Front Cover	Interchangeability in Dials help easy inventory	
Bezel	DIN Sized meters capable of mounting in mosaic grid	
Case	Glass, White ring and Black Gasket can be replaced easy.	
Terminal	The fitting is positive and unique.	
Protection	These are made of FR Grade Glass filled poly carbonate with Extra thick walls giving the meter additional mechanical strength Terminal shroud with a special design eliminates the risk of contact with live terminals	

Sizes	Cutout (AXA)
48x48mm	45x45mm
72x72mm	68x68mm
96x96mm	92x92mm
144x144mm	138x138mm

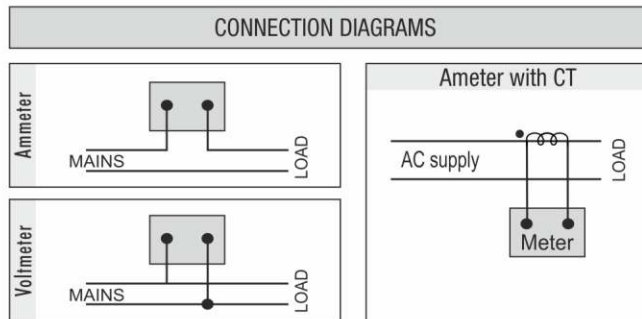
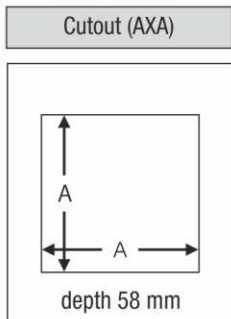

CURRENT TRANSFORMERS

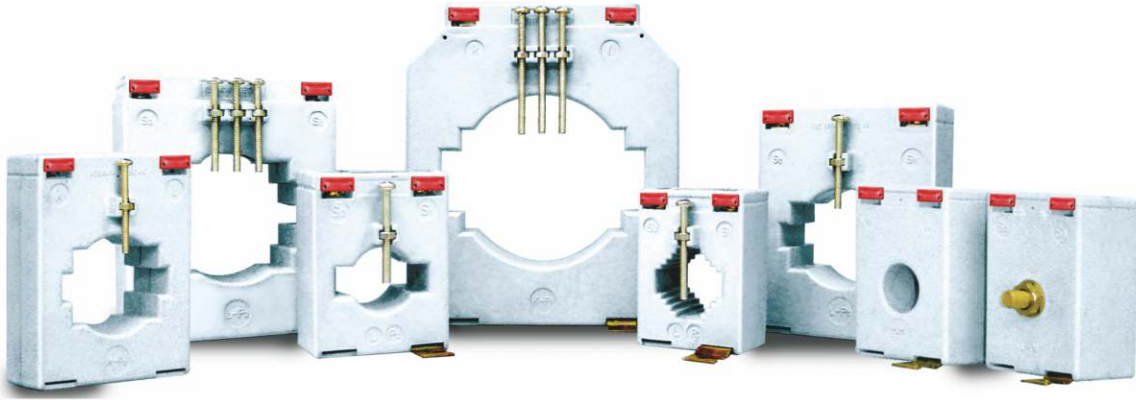

NE 201



Cable 20.4 mm

ACCURACY CLASS			
PRIMARY CURRENT	1VA	2.5VA	5VA
100	1		
150	1		
200		1	
250		1	
300		1	
400			1
500			1

NE 201

Overall DIM^N same as NE 201

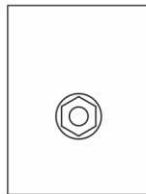

WOUND PRIMARY CT
size 78X 55X 40

ACCURACY CLASS		
PRIMARY CURRENT	2.5VA	5VA
20	1	
30	1	
40		1
50		1
60		1
75		1

NE 301

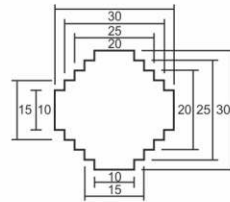

BUS BAR 30 X 10 mm

ACCURACY CLASS			
PRIMARY CURRENT	1VA	2.5VA	5VA
75	3		
80	3		
100	1		
125	1		
150	1	3	
200		1	
250		1	
300		1	
400			1

NE 401

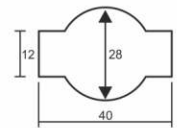

BUS BAR 40 X 12 mm

ACCURACY CLASS		
PRIMARY CURRENT	2.5VA	5VA
150	1	
200	1	
250	1	
300	1	
400		1
500		1
600		1

NE 501

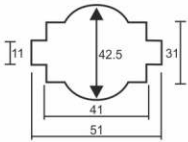

BUS BAR 51 X 11 mm

ACCURACY CLASS			
PRIMARY CURRENT	2.5VA	5VA	10VA
300	1.0		
400	1.0		
500	1.0		
600		1.0	
750		1.0	
800		1.0	
1000			1.0
1200			1.0
1250			1.0

NE 601

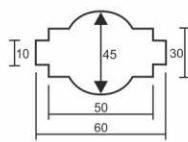

BUS BAR 60 X 10 mm

ACCURACY CLASS		
PRIMARY CURRENT	10VA	15VA
400	1	
500	1	
600	0.5	1
800	0.5	1
1000	0.5	1
1200		1
1500		1
1600		1

NE 801

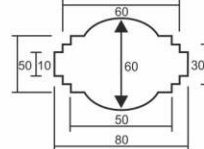

BUS BAR 80 X 10 mm

ACCURACY CLASS			
PRIMARY CURRENT	5VA	10VA	15VA
400	1		
500	1		
600	1		
800		0.5	1
1000		0.5	1
1200		0.5	1
1500		0.5	1
1600		0.5	1
2000		0.5	1

NE 1001

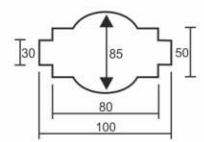

BUS BAR 100 X 30 mm

ACCURACY CLASS			
PRIMARY CURRENT	10VA	15VA	30VA
800	0.5	1	
1000		0.5	
1200		0.5	
1500		0.5	
1600		0.5	
2000		0.5	1
2500		0.5	1
3000			0.5
4000			0.5

RANGE	RATIO	WINDOW DIMENSIONS FOR BUS BAR (mm)	OVERALL DIMENSIONS H x W x TH (mm)
201	100/5A to 500/5A	20	70 x 55 x 45
301	75/5A to 400/5A	30 x 10	70 x 49 x 32
401	150/5A to 600/5A	40 x 12	78 x 60 x 32
501	300/5A to 1250/5A	51 x 11	92 x 85 x 32
601	400/5A to 1600/5A	60 x 10	108 x 85 x 32
801	400/5A to 2000/5A	80 x 10	122 x 100 x 40
1001	800/5A to 3000/5A	100 x 30	160 x 135 x 40

ACCESSORIES:

1. Mounting Brackets
2. Fixing Screw with insulated bush
for window type
3. Secondary Terminal Cover
4. DIN Rail adaptor (optional)

CURRENT TRANSFORMERS



NIPPEN current transformers comply with the highest international quality standard made according to BS 3938, IS-2705 or IEC185. CT's are available in BPCT & WPCT rated Voltage 660V, Secondary Current 5A or 1A in BPCT current range is 100 A - 3000 A, in WPCT below 75A, Rated Burden 1VA -30 VA. Current Transformers Low Tension Bar Primary (Ring type Tape Insulated Ct Are Secondary Coil Wound On Toroidal Core of High Permeability Silicon Steel)

Features	Suitable Terminal/ Wire type output Panel Mount
Rated Primary Rating	30A to 3000A
Rated Secondary output	5A
Rated burden	1VA to 15VA
Accuracy	1% to 5%
Thermal Noise Continuous	120 % of In
Thermal Short Circuit current(Icth)	Ith=60 X In for 1sec
Instrument security factor	FS<5
Insulation class	B
Max operating voltage(Um)	720 V max.
Isolation test voltage	3kV AC 1min
Nominal rated frequency	AC 50Hz
Max. lugs size	8mm
Frequency	50/60Hz
Applicable Standard	IEC 61869-2/IS 2705

ABS (RING TYPE)					
RANGE	ID	OD	HT	ACCURACY	VA BURDEN
30/5A	33	66	36	5%	3
50/5A	33	66	36	5%	3
60/5A	33	66	36	5%	3
75/5A	33	66	36	5%	3
100/5A	33	66	36	1.0%	5
150/5A	33	66	36	1.0%	5
200/5A	34	66	36	1.0%	5
250/5A	34	66	36	1.0%	5
200/5A	46	76	36	1.0%	5
250/5A	46	76	36	1.0%	5
300/5A	46	76	36	1.0%	5
400/5A	46	76	36	1.0%	5
300/5A	60	100	36	1.0%	10
400/5A	60	100	36	1.0%	10
500/5A	60	100	36	1.0%	10
600/5A	60	100	36	1.0%	10
800/5	80	100	35	1.0%	10
1000/5	80	100	35	1.0%	15
1200/5	80	100	35	1.0%	15
1500/5	100	135	35	1.0%	15
1600/5	100	135	35	1.0%	15
2000/5	100	135	35	1.0%	15
2500/5	100	135	35	1.0%	15
3000/5	100	135	35	1.0%	15

NP-SERIES			
PRODUCT CODE	CURRENT RATIO	BURDEN IN VA	ACCURACY CLASS
NP-301/30-60/5A	60 / 5	1	5
NP-301/30-75/5A	75 / 5	1	1
NP-301/30-80/5A	80 / 5	1	1
NP-301/30-100/5A	100 / 5	1	1
NP-301/30-125/5A	125 / 5	1.25	1
NP-301/30-160/5A	160 / 5	1.5	1
NP-301/30-200/5A	200 / 5	3	1
NP-301/30-250/5A	250 / 5	3	1
NP-301/30-400/5A	400 / 5	5	1
NP-401/30-30/5A	30/5	1	5
NP-401/30-50/5A	50/5	1	3
NP-401/30-50/5A	50/5	1.5	3
NP-401/30-75/5A	75/5	1	3
NP-401/30-75/5A	75/5	3	3
NP-401/30-100/5A	100/5	1	1
NP-401/30-100/5A	100/5	3	1
NP-401/30-100/5A	100/5	1	1
NP-401/30-125/5A	125/5	1	1
NP-401/30-150/5A	150/5	1.5	1
NP-401/30-150/5A	150/5	3	1
NP-401/30160/5A	160/5	1.5	1
NP-401/30-200/5A	200/5	2.5	0.5
NP-401/30-200/5A	200/5	3	1
NP-401/30-250/5A	250/5	2.5	0.5
NP-401/30-250/5A	250/5	3	1
NP-401/30-300/5A	300/5	3	0.5
NP-401/30-400/5A	400/5	3.75	0.5
NP-401/30-400/5A	400/5	5	1
NP-801/60-500/5A	500/5	5	1
NP-801/60-600/5A	600/5	5	0.5
NP-801/60-600/5A	600/5	7.5	1
NP-801/60-800/5A	800/5	10	0.5
NP-801/60-1000/5A	1000/5	15	0.5
NP-801/60-1200/5A	1200/5	15	0.5
NP-1001/100-800/5A	800/5	15	0.5
NP-1001/100-1000/5A	1000/5	15	0.5
NP-1001/100-1000/5A	1200/5	15	0.5
NP-1001/100-1250/5A	1250/5	15	0.5
NP-1001/100-1500/5A	1500/5	15	0.5
NP-1001/100-1600/5A	1600/5	15	0.5
NP-1001/100-2000/5A	2000/5	15	0.5
NP-1001/100-2500/5A	2500/5	15	0.5
NP-1001/100-2000/5A	3000/5	15	0.5
NP-1001/100-2500/5A	2500/5	15	0.5
NP-1001/100-3000/5A	3000/5	15	0.5
NP-1001/100-3500/5A	3500/5	15	0.5
NP-1001/100-4000/5A	4000/5	15	0.5

Note: All New Products are available after 1st quarter 2023

INSULATION TESTERS



FEATURES

- 4 Digit Large (1") LCD display with backlight
- Insulation Range upto 2000 MΩ & Voltage upto 1000V
- Over range Indication
- Battery status & battery charging status
- Auto power OFF
- Rechargeable, Li-ion Battery

Display	4 Digit Large (1"), 9999 Counts LCD display with backlight
Measurement Ranges	100V/500V/1000V for 100MΩ/1000MΩ/2000MΩ 250V/500V/1000V for 200MΩ/1000MΩ/2000MΩ
Measurement Type	Line, Earth & Guard
Resolution	<1.6mA
Accuracy	±4% rdg +2 dgt
Power Supply	1500mAh Li-ion Rechargeable battery (3.7V DC)
Low Battery Indication	 (Battery Flashing Symbol appears on Display)
Auto Shutdown	10 Minutes
Data Hold Indication	HOLD (Symbol Appears on Display)
Accessories	Rexine Cover, Charger, Instruction manual, Test report, Batteries.
Environmental Specifications	Operating Temperature: -5° to 40° Storage temperature: -20° to 60° Relative humidity: 80% RH
Physical Specifications	Net Weight: 250gm Gross Weight: 400gm Dimensions (HxWxL): 140mm x 94mm x 48mm

Note: All New Products are available after 1st quarter 2023



Test Voltage (V)	Range (Mega Ohms)
100V	20 MΩ
250V	50 MΩ
500V	100 or 1000 MΩ
1000V	200 or 2000 MΩ
2500V	2000 or 5000 MΩ
5000V	10000 or 20000 MΩ

Accuracy	+/- 5%
Casing	ABS or Metal Body.
Type	Hand cranking
IS Standard	Complies with IS 2992
Size (approx.)	178mm (D) X 122mm (W) X 126mm (H)
Weight (approx.)	2 Kgs.
Accessories (Supplied with instrument)	Instruction manual & Meter carrying case.
Accessories (Supplied optional at extra charge)	A Rexine Kit consisting of hammer, 1 screw driver, 4 spools of wires, 4 M.S Spikes.

INSULATION TESTERS

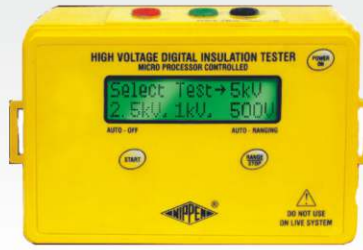

Display	2 line x 16 character Large LCD alphanumeric Display			
Range selection	500V DC 10000 MΩ	1000V DC 25000 MΩ	2500V DC 100000 MΩ	5000V DC 200000 MΩ
Automatic discharge	After automatic & manual stop or upon completion of test			
Low battery indicator	"Recharge battery" when displayed battery voltage is low			
Power source	Lithium Ion battery & 13V DC adapter charger			
Auto Power off	After 30 seconds in static mode +20 seconds of Beep			
Energy Save Mode	Shorter test time to conserve battery life			
Operating conditions	32 to 104 F(0 ^o to 40 ^o C); 80% RH			
Storage conditions	40 to 140 F(-10 ^o to 60 ^o C); 80% RH			
Dimensions	6.5 X 4.1 X 3.5"(158 X 102 X 85mm)			
Weight (including Battery)	1.94 lbs (620g)			
Accessories Supplied	1. Rechargeable Battery & Charger. 2. A Set of low noise one meter Long Leads with multipurpose detachable crocodile clip. 3. Instruction Manual. 4. Carrying Case.			

Warning & Display of External Voltage Present Smart Microprocessor Controlled Better than 5% Accuracy

RANGE SPECIFICATIONS

Test Voltage	Resistance Range	Short Circuit Current	Accuracy	Resolution
250/500/1000V DC	5/10/25 GΩ	1mA	0 to 10GΩ : ± 3% reading 10 to 200GΩ : ± 5% reading	1MΩ
500/1000/2500V DC	10/25/100 GΩ	1mA		
500/1000/2500/5000V DC	10/25/100/200 GΩ	1mA		

OPERATION

Note: Ensure that the circuit under test does not include devices or components that can be damaged by 5000V, such devices include power factor correction capacitors, low voltage insulated cables, electronic light dimmers, ballasts and starters for fluorescent lamps. Connecting the Test Leads to the meter The Black (EARTH) and Red (LINE) test leads connect to the meter in the lead compartment located on the back of the meter (the meter jacks are color coded).

OPTIONAL

1. Polarization Index With RS 232
2. Dielectric constant

APPLICATION

The insulation tester will find applications in electrical contracting both on domestic & industrial systems and on-site maintenance departments. It is suitable for insulation measurements during installation, servicing & maintenance work. This instrument is ideal for testing Transformers, Motors, Generators, Switchgear, Domestic Appliances, Power Tool Power cables, etc as well as fixed wiring systems. By virtue of its capacity to take fast readings, is well suited to test relays, switchgear & contactors.

EARTH TESTERS



FEATURES

- 4 Digit Large (1") LCD display with backlight
- Auto ranging upto 2000Ω
- Battery status & battery charging status
- Auto power OFF
- Rechargeable Li-ion Battery

Display	4 Digit Large (1"), 9999 Counts LCD display with backlight
Measurement Ranges	Auto ranging from 20Ω to 2000Ω
Measurement Type	4 Wire Method
Resolution	0-20Ω(0.01 Ω), 0-200 Ω(0.1 Ω), 0-2000 Ω(1 Ω)
Accuracy	±4% rdg. +2 dgt.
Power Supply	1500mAh Li-ion Rechargeable battery (3.7V DC)
Low Battery Indication	1 (Symbol Appears on Display)
Auto Shutdown	☐ (Battery Flashing Symbol appears on Display)
Data Hold Indication	HOLD (Symbol Appears on Display)
Accessories	Rexine Cover,Charger, Instruction manual, Test report, Batteries.
Environmental Specifications	Operating Temperature: -5° to 40° Storage temperature: -20° to 60° Relative humidity: 80% RH
Physical Specifications	Net Weight: 250gm Gross Weight: 400gm Dimensions (LxWxH): 146mm x 94mm x 48mm

Note: All New Products are available after 1st quarter 2023



Earth Resistance testers are used for measuring of earth electrode resistance, soil resistance, earth continuity, neutral & Earth loop resistance, resistance of various components etc. Useful for Railways, Defence, Electricity Boards, Power generating Plants, Geological Surveyors, Industries etc. Four terminal measurement system avoids errors due to spikes and testing wires resistance.

Accuracy	+/- 5%
Terminals	4mm screw type.
Power Source	Models SET/ DET/ TET are provided with hand operated AC generator having delrin moulded gears, self lubricating sintered bearings, stainless steel collapsible handle with handle knob and housed in polycarbonate casing.
IS Standard	Models SET/ DET/ TET confirms to IS-9223 of 1989
Size (approx.)	178mm (D) X 122mm (W) X 126mm (H) for SET/ DET/ TET
Weight (approx.)	2 Kgs. For SET/ DET/ TET
Accessories (Supplied with instrument)	Instruction manual & Meter carrying case
Accessories (Supplied optional at extra charge)	A Rexine Kit consisting of hammer,1 screw driver, 4 spools of wires, 4 M.S. Spikes

MODEL	RANGES (ohms)
SET - 3, 10, 30, 50, 100, 500, 1000	Single Range 0 to 3, 0 to 10, 0 to 30, 0 to 50, 0 to 100, 0 to 500, 0 to 1000
DET - 3, 5, 10, 30, 50, 100	Dual Range 0-3/30, 0-5/50, 0-10/100, 0-30/300, 0-50/500, 0-100/1000
TET - 3, 5, 10	Triple Ranges 0-3/30/300, 0-5/50/500, 0-10/100/1000

ADVANCE STATIC VAR GENERATOR (ASVG)

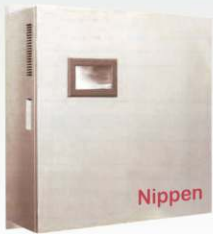

- PFC performance 0.99
- Step-less compensation without over-compensation & under-compensation compensate specific capacity that system need.
- Full PFC process within 15 ms & maintain at PFC 0.99 no matter how the system reactive power changes.
- Compensation with inductive reactive power & capacitive reactive power.
- The voltage of the grid has little influence on SVG compensation capacity as SVG is like a current source
- Could work under high THDU up to 15% no capacitor explosion risk & no safety accident.
- Minimal loss, maintenance-free & no need to replace cap bank every certain time.
- MTBF (mean time between failures) upto 100,000 hours, helps consumers lower the cost
- Advanced technology & easy to use with HMI monitor
- Minimal footprint to save more than 70% space compared with cap bank.

Item	400V/415V		
	Nippen SVG 030	Nippen SVG 050	Nippen SVG 100
SYSTEM PARAMETERS			
Rated input line voltage	400V/415V L-L		
Input Phase Voltage range	228V ~ 456V L-L		
power grid frequency	50Hz/60Hz (range: 45Hz ~ 62.5Hz)		
Parallel operation	Unlimited		
Overall efficiency	>97%		
power grid structure	3P3L/3P4L		
CT	150/5 ~ 10,000/5		
Circuit topology	3 Level		
PERFORMANCE INDICATORS			
Single-Module compensation capacity	30kVar	50kVar	100kVar
Response time	<15ms		
Target power factor	Adjustable from -1 to +1		
cooling mode	Smart air cooling: 220L/sec		Smart air cooling: 405L/sec
noise level per module	<65dB		
COMMUNICATION & MONITORING CAPABILITIES			
Communications ports	Rs485, CAN (reserved) & Ethernet port (Rj45)		
Communications protocols	Modbus		
Alarm	Available		
Monitoring	4.3 inch touch screen monitor & optional 7 inch touch screen centralized monitor		
Mechanical properties			
Mounting type	Rack mounted, Wall mounted & Cabinet		
Cable entry mode	Rear entry for rack mounted type, top entry for wall mounted type top or bottom entry for cabinet		
Dimensions (WxDxH)	400x445x150mm (Rack mounted)	500x557x190mm (Rack mounted)	500x520x269mm (Rack mounted)
	440x160x481mm (Wall mounted)	500x191x582mm (Wall mounted)	500x271x553mm (Wall mounted)
Module net weight	21kg	35kg	48kg
Color	RAL7035(gray)		
ENVIRONMENT REQUIREMENT			
Altitude	1500m. Between 1500m & 4000m, according to GB/T3859.2, the power decreases by 1% for every additional 100m		
Ambient temperature	-10°C~40°C (may derate capacity if ambient temperature exceeds 45°C)		
Relative humidity	5% ~ 95%, Non-condensing		
Protection grade	IP20 (other IP degrees are customizable)		
RELATED QUALIFICATIONS & STANDARDS			
Qualification	CE		
Standards compliance	IEEE519, ER GS/4		

* ASVG will be available after 3rd quarter 2023

ACTIVE HARMONIC FILTER(AHF)



- Ultra-compact design, wall & rack mount installation, easy to use in new or exiting switch room upgraded
- Module structure with highest reliability of system
- Unique intelligent FFT algorithm automatically study the electrical system impedance, to prevent system from resonance, high system reliability
- Real time electrical system resonance monitor & management
- Module 4.3 inch HMI
- Display electrical system voltage, current, frequency, before & after THDi, Apparent/Active/Reactive power, etc
- Display before & after waveform, spectrum in same page with clearly comparison

Items	400V/415V L-L Nippen AHF
SYSTEM PARAMETERS	
Rated Input	380V / 415V(228V~456V) L-L
Power Grid Frequency	50/60Hz (range: 45Hz~62.5Hz)
Parallel Quantities	Unlimited
Efficiency	>97%
Power Grid Structure	3P3W/3P4W
CT	50/5A~10,000/5A
Circuit Topology	3 Level
PERFORMANCE INDICATORS	
Rated Capacity	25/35/50A
Harmonic Compensation	Available
Reactive Power Compensation	Available
Unbalance Compensation	Available
Control Algorithm	FFT, Intelligent FFT, & instantaneous reactive power
Operation Mode	12 combination, set up priority
Filtering Range	2nd to 61th orders
Filtering Order	2nd to 61th orders
Filtering Degree	2nd to 61th orders
Filtering Performance	>95%
Reaction Time	<15 μ s
Overall Response Time	5ms
Target power factor	Adjustable from -1 to +1
Switching frequency	90KHz
Cooling air requirement	75L/sec-151L/sec
Noise Level	<55dB
COMMUNICATION & MONITORING CAPABILITIES	
Communications Ports	RS485
Communciations Protocols	Modbus
Module Display Interface	4.3 inch HMI
Protection Functions	Over voltage protection, under voltage protection, short-circuit protection, inverter bridge, inverse protection, over-compensation protection & so on
Monitoring Alarm	Available
Fault Alarm	Alarm record on request
MECHANICAL PROPERTIES	
Mounting Type	Rack mounted, Wall mounted
Dimensions (wxdxh)mm	400x325x44.5mm (Rack mounted) 400x44.5x325mm (Wall mounted)
Net Weight	4.98kg
Color	Black
ENVIRONMENT REQUIREMENT	
Altitude	<1500m, Between 1500m & 4000m, according to GB/T3859.2, the power decreases by 1% for every additional 100m
Ambient Temperature	-10 $^{\circ}$ C~40 $^{\circ}$ C (may derate capacity if ambient temperature exceeds 45 $^{\circ}$ C)
Relative Humidity	5% to 95%, Non-condensing
Protections Class	IP20
RELATED QUALIFICATIONS & STANDARDS	
Qualifications	CE, IEEE 61000
Standards Compliance	IEEE519, ER GS/4

* AHF will be available after 3rd quarter 2023

SMART NET REAL TIME SYSTEM

Based Energy Management Monitor Energy, any Where, anytime

Smart Net Real Time System is a web based service for monitoring energy consumption, cost, operational efficiency and system status .It provides all the information an organization need to manage its power system and reduce its energy costs. It enables the performance of the energy system to be optimized, through features including consumption monitoring, analysis and alerts issued using mobile technology.

Smart Net Real Time System enables the exchange of data from different utilities, such as electricity, gas heat and water. Live data from energy measuring points can be viewed in real time from any location with internet access

Applications

- Industry, micro, small and medium enterprise (MSMEs)
- Factories, offices, commercial building, hotels and institutions
- Industries and building purchasing power under open access
- Distributed generators and discrete loads
- Sub-tenant billing
- Multi –location retail chains

Features

- Real –time personalized dashboards
- Shift wise energy monitoring and analysis
- Consumption reports for energy groups
- User configurable spreadsheet based reports
- Production data can be entered
- Historical graphs and trends
- “Virtual meter” for in- depth analysis of a group
- Provision to integrate gas, heat and water
- Tariff module for cost calculations
- Target demand and open access schedule monitoring
- Alerts for deviations from targeted consumption
- Downloadable reports via e-mail or spreadsheet
- Choice of package to suit individual need

Mobile Application

- It has a key feature of providing all the monitoring over Mobile application, which is available for Android and IOS Smart phone
- Users download the application and run it with the same login created during service purchase
- User gets instant alerts /event notification over application.
- User can configure new gateway and can view the data anywhere at anytime.

Benefits

- Helps create cost awareness for utility consumption(electricity, Gas, Heat and Water)
- Isolate waste from efficiency
- Set realistic targets for energy consumption
- Verify the effectiveness of operational charge
- Learn where and when energy is consumed
- Carbon emissions through meaningful real -time display
- Monitor the performance of geographically distributed assets as required, even while on the move
- Enables and encourages active participation by mangers and Staff
- Provides accurate information from any location with internet Access
- Helps energy efficiency certification targets to be met
- Affordable licensing arrangement spread the cost and provide lifetime saving

Skyline gateway

- Daisy chain connection for multiple meter
- Gateway collects data from meters
- Direct Ethernet communications also supported
- Gateway sends data to Smart Net System central data centre (CDC) over GPRS/ RF/ETHERNET etc

MEASURE IT

DETECT IT

CONTROL IT

SAVE IT

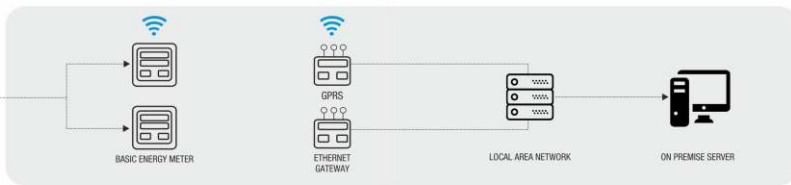

CUSTOMER WEB PORTAL | MOBILE APPLICATION

- Online Customer login portal/ Mobile application login.
- User can get balance /credit through any of the interface (Mobile /Web-portal) or through Applications.
- Remote switch ON/OFF through mobile application
- Information through smart mobile application on need of Remote Display.



ALERTS OVER EMAIL/SMS

- Warning SMS at 20% and 10% of kWh threshold level, also tariff crossover.
- Sending SMS to the users during power outage.
- Get alerts for activities like account recharge, Recharge status, Low Credit, Overload, Over voltage, etc.



ENERGY BILLS, CONSUMPTION & PRICING

- Real time data monitoring.
- Recharge SMS, Recharge history for the selected date range.
- Monthly billing with breakup of EB/DG
- Running Hours of DG and Mains Supply is Provided.
- Cheque reconciliation.



DASHBOARD



REAL TIME/LINE DIAGRAM

REPORTS



E-MAIL, SMS, ONLINE REPORTS

ANALYTICS



PERIODIC EXCEL, PDF

HISTORY



BUSINESS INTELLIGENCE
MULTI PARAMETER GRAPH

CONTROL



MANUAL OVERRIDE SCHEDULED

BILLING



AUTOMATIC TARIFF BASED

IoT SOLUTIONS

IoT GATEWAYS



Specifications	GPRS-4G-W	NG-9W-WF	NG-9W-EN
Frequency Bands	LTE FDD: B1/B3/B5/B8 LTE TDD: B34/B38/B39/B40/B41 Class 3 (23dBm±2dB) for LTE bands Class 1 (1W @ 1800/1900 MHz)		
Band		Single Stream in 2.4 GHz ISM band	
Interface			RJ 45 Ethernet 10 BASE-T or 100 BASE -TX (Auto)
GPRS	4G single-slot class 12 mobile station class B		
Security		IEEE 802.11 WEP, WPA, WPA2 security	
Speed			10/100 Ethernet Half / Full Duplex (Auto negotiating)
SIM Interface	Full size - 3.3V or 1.8V compatible		
Output Power		18.5dBm (802.11b 11Mbps)	
Modbus protocol			Modbus RTU Master
Transmit Protocol	TCP, HTTP and MQTT	Configurable TCP,HTTP	Configurable TCP, HTTP, HTTPS
OTA	Firmware Updating via 4G	Firmware Updating via FTP	Firmware Updating via FTP
Antenna	External 3 meter extendable antenna	External 3 meter extendable antenna	
Power Supply			12V to 24V DC (Reverse Polarity Protection)
Digital Port	RS-232 or RS-485		
Electrical Standard		TTL or RS232 or Rs485	TTL or RS-232 or RS-485
RS-485 Port	Multiple Modbus Slave Device Connection	Multiple Modbus Slave Device Connection	Multiple Modbus Slave Device Connection
RS-485 Modes	Transparent / Modbus Polling Formatted	Transparent / Modbus Polling Formatted (ASCII / HEX / RawHEX)	Transparent / Modbus Polling Formatted (ASCII / HEX / RawHEX)
Input Port	2 Channels (0 to 24V) Analog / Digital Input	2 Channel (0 to 24V) Analog/Digital Input	2 Chanel (0 to 24V) Analog / Digital Input
Analog Port	1 Channel 4 to 20 mA (optional with relay out)		
RS-232 PORT		PC Utility for Device Configuration	PC Utility for Device Configuration
LED Indicator	Power, 4G, Modbus Communication Status	Power, IP, Modbus Communication Status	Power, IP, Modbus Communication Status
Connector	5 mm Micro-Fit connectors	Micro Fit-5.0 (8 pins – 2 Power / 2 Modbus / 2 IOs)	Micro Fit-5.0 (8 pins – 2 Power / 2 Modbus / 2 IOs)
Dimensions	100mm x 85mm x 24mm (L x W x H)	100mm x 85mm x 24mm (L x W x H)	100mm x 85mm x 24mm (L x W x H)
Weight	160 grams	160 grams	160 grams
Operating voltage	10V to 24V DC	10V - 24V DC	10V - 24V DC
Operating Temperature	-10C to +55C	-10C to +55C	-10C to +55C

ORDERING INFORMATION

DIGITAL PANEL METERS

PRODUCT NAME	DESCRIPTIONS
DA-1 (96)	DIGITAL AMMETER 1PHASE 96X96
DA-1 (48)	DIGITAL AMMETER 1PHASE 48X96

PRODUCT NAME	DESCRIPTIONS
DA-3 (SINGLE ROW) 96	DIGITAL AMMETER 3PHASE SINGLE ROW 96X96
DA-3 (SINGLE ROW) 48	DIGITAL AMMETER 3PHASE SINGLE ROW 48X96

PRODUCT NAME	DESCRIPTIONS
DA-33 (THREE ROW)	DIGITAL AMMETER 3PHASE THREE ROW

Note: DIRECT BUILT IN CURRENT TRANSFORMER UPTO 30A (MODEL WITH EXTENTION DCT).

PRODUCT NAME	DESCRIPTIONS
DF-1(96)	DIGITAL FREQUENCY METER 96X96
DF-1(48)	DIGITAL FREQUENCY METER 48X96

PRODUCT NAME	DESCRIPTIONS
DM-PF-11	DIGITAL POWER FACTOR 1 PHASE VOLTAGE 1 PHASE CURRENT
DM-PF-31	DIGITAL POWER FACTOR 3 PHASE VOLTAGE 1 PHASE CURRENT
DM-PF-33	DIGITAL POWER FACTOR 3 PHASE VOLTAGE 2 PHASE CURRENT
DM-PF-34	DIGITAL POWER FACTOR 3 PHASE VOLTAGE 3 PHASE CURRENT

PRODUCT NAME	DESCRIPTIONS
DV-1 (96)	DIGITAL VOLTMETER 1PHASE 96X96
DV-1 (48)	DIGITAL VOLTMETER 1PHASE 48X96

PRODUCT NAME	DESCRIPTIONS
DV-3 (SINGLE ROW) 96	DIGITAL VOLTMETER 3PHASE 1ROW 96X96
DV-3 (SINGLE ROW) 48	DIGITAL VOLTMETER 3PHASE 1ROW 48X96

PRODUCT NAME	DESCRIPTIONS
DV-33 (3ROW)	DIGITAL VOLTMETER 3PHASE 3ROW

PRODUCT NAME	DESCRIPTIONS
DM-W-11	DIGITAL WATTMETER 1 PHASE 1 ELEMENT
DM-W-33	DIGITAL WATTMETER 3 PHASE 2 ELEMENT
DM-W-34	DIGITAL WATTMETER 3 PHASE 3 ELEMENT

PRODUCT NAME	DESCRIPTIONS
DT36L	VAF METER DT36L

PRODUCT NAME	DESCRIPTIONS
DT36M-1PH	VAF METER DT36M 1PHASE
DT36M-3PH	VAF METER DT36M 3PHASE

DIGITAL PANEL METERS

PRODUCT NAME	DESCRIPTIONS
EM3010-1PH	ENERGY METER 1 PHASE 96X96
EM3010-1PH-RS	ENERGY METER 1 PHASE 96X96 RS485
EM3010-1PH-DG	ENERGY METER 1 PHASE 96X96 DG
EM3010-1PH-RS-DG	ENERGY METER 1 PHASE 96X96 RS485-DG
EM3010-3PH	ENERGY METER 3 PHASE 96X96
EM3010-3PH-RS	ENERGY METER 3 PHASE 96X96 RS485
EM3010-3PH-DG	ENERGY METER 3 PHASE 96X96 DG
EM3010-3PH-RS-DG	ENERGY METER 3 PHASE 96X96 RS485-DG

PRODUCT NAME	DESCRIPTIONS
EM3010 VA-1PH	ENERGY METER 1 PHASE 96X96
EM3010 VA-1PH-RS	ENERGY METER 1 PHASE 96X96 RS485
EM3010 VA-1PH-DG	ENERGY METER 1 PHASE 96X96 DG
EM3010 VA-1PH-RS-DG	ENERGY METER 1 PHASE 96X96 RS485-DG
EM3010 VA-3PH	ENERGY METER 3 PHASE 96X96
EM3010 VA-3PH-RS	ENERGY METER 3 PHASE 96X96 RS485
EM3010 VA-3PH-DG	ENERGY METER 3 PHASE 96X96 DG
EM3010 VA-3PH-RS-DG	ENERGY METER 3 PHASE 96X96 RS485-DG

PRODUCT NAME	DESCRIPTIONS
EM3013-1PH	ENERGY METER 1 PHASE 96X96
EM3013-1PH-RS	ENERGY METER 1 PHASE 96X96 -RS485
EM3013-1PH-DG	ENERGY METER 1 PHASE 96X96 -DG
EM3013-1PH-RS-DG	ENERGY METER 1 PHASE 96X96 -RS485-DG
EM3013-3PH	ENERGY METER 3 PHASE 96X96
EM3013-3PH-RS	ENERGY METER 3 PHASE 96X96 -RS485
EM3013-3PH-DG	ENERGY METER 3 PHASE 96X96 -DG
EM3013-3PH-RS-DG	ENERGY METER 3 PHASE 96X96 -RS485-DG

Note: 1) BUILT IN MODEL WITH EXTENSION ETHERNET.
2) DIRECT BUILT IN CURRENT TRANSFORMER UPTO 60A (MODEL WITH EXTENTION DCT).

PRODUCT NAME	DESCRIPTIONS
EM3060-1PH	ENERGY METER 1 PHASE 96X96
EM3060-1PH-RS	ENERGY METER 1 PHASE 96X96 RS485
EM3060-1PH-DG	ENERGY METER 1 PHASE 96X96 DG
EM3060-1PH-RS-DG	ENERGY METER 1 PHASE 96X96 RS485-DG
EM3060-3PH	ENERGY METER 3 PHASE 96X96
EM3060-3PH-RS	ENERGY METER 3 PHASE 96X96 RS485
EM3060-3PH-DG	ENERGY METER 3 PHASE 96X96 DG
EM3060-3PH-RS-DG	ENERGY METER 3 PHASE 96X96 RS485-DG

PRODUCT NAME	DESCRIPTIONS
EM3060-VA-1PH	EM3060-VA 1 PHASE 96X96
EM3060-VA-1PH-RS	EM3060-VA 1 PHASE 96X96 RS485
EM3060-VA-1PH-DG	EM3060-VA 1 PHASE 96X96 DG
EM3060-VA-1PH-RS-DG	EM3060-VA 1 PHASE 96X96 RS485-DG
EM3060-VA-3PH	EM3060-VA 3 PHASE 96X96
EM3060-VA-3PH-RS	EM3060-VA 3 PHASE 96X96 RS485
EM3060-VA-3PH-DG	EM3060-VA 3 PHASE 96X96 DG
EM3060-VA-3PH-RS-DG	EM3060-VA 3 PHASE 96X96 RS485-DG

PRODUCT NAME	DESCRIPTIONS
EM3063-1PH	ENERGY METER 1 PHASE 96X96
EM3063-1PH-RS	ENERGY METER 1 PHASE 96X96 RS485
EM3063-1PH-DG	ENERGY METER 1 PHASE 96X96 DG
EM3063-1PH-RS-DG	ENERGY METER 1 PHASE 96X96 RS485-DG
EM3063-3PH	ENERGY METER 3 PHASE 96X96
EM3063-3PH-RS	ENERGY METER 3 PHASE 96X96 RS485
EM3063-3PH-DG	ENERGY METER 3 PHASE 96X96 DG
EM3063-3PH-RS-DG	ENERGY METER 3 PHASE 96X96 RS485-DG

Note: 1) BUILT IN MODEL WITH EXTENSION ETHERNET.
2) DIRECT BUILT IN CURRENT TRANSFORMER UPTO 60A (MODEL WITH EXTENTION DCT).

ORDERING INFORMATION

MULTIFUNCTION METERS

PRODUCT NAME	DESCRIPTIONS
DT3600-1PH	MFM DT3600-1PHASE
DT3600-1PH-RS	MFM DT3600-1PHASE-RS485
DT3600-1PH-AL	MFM DT3600-1PHASE-ALARM
DT3600-1PH-AL-RS	MFM DT3600-1PHASE-ALARM-RS485
DT3600-3PH	MFM DT3600-3PHASE
DT3600-3PH-RS	MFM DT3600-3PHASE-RS485
DT3600-3PH-AL-RS	MFM DT3600-3PHASE-ALARM
DT3600-3PH-AL	MFM DT3600-3PHASE-ALARM-RS485
DT3600-3PH-RELAY 0/P-AL	MFM DT3600-3PHASE-RELAY 0/P ALARM
DT3600-3PH-RELAY 0/P-AL-RS	MFM DT3600-3PHASE-RELAY 0/P ALARM-RS485

PRODUCT NAME	DESCRIPTIONS
DT3600 KWH-1PH	MFM DT3600 KWH-1PHASE
DT3600 KWH-1PH-RS	MFM DT3600 KWH-1PHASE- Rs485
DT3600 KWH-1PH-AL	MFM DT3600 KWH-1PHASE- ALARM
DT3600 KWH-1PH-AL-RS	MFM DT 3600 KWH-1PHASE- ALARM- Rs485
DT3600 KWH-3PH	MFM DT3600 KWH-3PHASE
DT3600 KWH-3PH-RS	MFM DT3600 KWH-3PHASE- Rs485
DT3600 KWH-3PH-AL	MFM DT3600 KWH-3PHASE- ALARM
DT3600 KWH-3PH-AL-RS	MFM DT 3600 KWH-3PHASE- ALARM- Rs485

PRODUCT NAME	DESCRIPTIONS
DT108-1PH	MFM DT108 1PHASE
DT108-1PH-DG	MFM DT108 1PHASE -DG
DT108-1PH-RS	MFM DT108 1PHASE -Rs485
DT108-1PH-AL	MFM DT108 1PHASE -ALARM
DT108-1PH-DG-RS	MFM DT108 1PHASE -DG- Rs485
DT108-1PH-DG-RS-AL	MFM DT108 1PHASE -DG- RS485 -ALARM
DT108-3PH	MFM DT108 3PHASE
DT108-3PH-DG	MFM DT108 3PHASE- DG
DT108-3PH-RS	MFM DT108 3PHASE -Rs485
DT108-3PH-AL	MFM DT108 3PHASE -ALARM
DT108-3PH-DG-RS	MFM DT108 3PHASE -DG -Rs485
DT108-3PH-DG-RS-AL	MFM DT108 3PHASE -DG- RS485 -ALARM

Note: 1) Built in Model with extension Ethernet.
2) Direct built in Current Transformer upto 60A (Model with Extension DCT).

PRODUCT NAME	DESCRIPTIONS
DT 108+ 1PH	MFM DT108 + 1PH
DT 108+ 1PH-RS	MFM DT108 + 1PH Rs485
DT 108+ 1PH-RS-DG	MFM DT 108 + 1PH RS-DG
DT 108+ 1PH-AL	MFM DT108 + 1PH ALARM
DT 108+ 1PH -DG	MFM DT108 + 1PH DG
DT 108+ 1PH-DG-AL-RS	MFM DT108 + 1PH -DG-ALARM-RS485
DT 108+ 3PH	MFM DT108 + 3PH
DT 108+ 3PH-RS	MFM DT108 + 3PH -Rs485
DT 108+ 3PH-RS-DG	MFM DT 108 + 3PH RS485-DG
DT 108+ 3PH-AL	MFM DT108 + 3PH -ALARM
DT 108+ 3PH -DG	MFM DT108 + 3PH -DG
DT 108+ 3PH-DG-AL-RS	MFM DT108 + 3PH -DG-ALARM-RS485

Note: 1) Built in Model with extension Ethernet.
2) Direct built in Current Transformer upto 60A (Model with Extension DCT).

PRODUCT NAME	DESCRIPTIONS
MFM804-3PH	MFM804 3 PHASE 96X96
MFM804-3PH-RS	MFM804 3 PHASE 96X96 -Rs485

PRODUCT NAME	DESCRIPTIONS
MFM804S-3PH	MFM804 3 PHASE 96X96
MFM804S-3PH-RS	MFM804 3 PHASE 96X96 -RS485

DIGITAL PANEL METERS

PRODUCT NAME	DESCRIPTIONS
DA-1(72)	DIGITAL AMMETER 1PHASE 72X72
DV-1(72)	DIGITAL VOLTMETER 1PHASE 72X72
DVA (72)	DIGITAL AMMETER VOLTMETER 1PHASE 72X72

SMART LOAD MANAGER

PRODUCT NAME	DESCRIPTIONS
SL6300-3PH	SMART LOAD MANAGER 3 PHASE 96X96
SL6300-3PH-RS	SMART LOAD MANAGER 3 PHASE 96X96 -Rs485
SL6300-3PH-DG	SMART LOAD MANAGER 3 PHASE 96X96- DG
SL6300-3PH-DG-RS	SMART LOAD MANAGER 3 PHASE 96X96 -DG- Rs485
SL6300-3PH-AL	SMART LOAD MANAGER 3 PHASE 96X96 -ALARM
SL6300-3PH-AL-RS	SMART LOAD MANAGER 3 PHASE 96X96- ALARM -Rs485
SL6300-3PH-RS-DG-AL	SMART LOAD MANAGER 3 PHASE 96X96 Rs485- DG-ALARM

PRODUCT NAME	DESCRIPTIONS
SL6300MDC-2RELAY-AL	SMART LOAD MANAGER MDC 96X96 2RELAY WITH ALARM
SL6300MDC-2RELAY-RS485-AL	SMART LOAD MANAGER MDC 96X96 2RELAY WITH ALARM Rs485
SL6300MDC-4RELAY-AL	SMART LOAD MANAGER MDC 96X96 4RELAY WITH ALARM
SL6300MDC-4RELAY-RS485-AL	SMART LOAD MANAGER MDC 96X96 4RELAY WITH ALARM -Rs485

Note: 1) Built in Model with Extension Ethernet.
2) Direct built in Current Transformer upto 60A (Model with extension DCT).

ORDERING INFORMATION

AUTOMATIC POWER FACTOR CONTROLLER

PRODUCT NAME	DESCRIPTIONS
APFC414-1CT-1PH-4R	APFC 414-96X96 1CT 1PH 4 STAGE-230V
APFC414-1CT-1PH-6R	APFC 414-96X96 1CT 1PH 6 STAGE-230V
APFC414-1CT-1PH-8R	APFC 414-96X96 1CT 1PH 8 STAGE-230V
APFC414-1CT-1PH-12R	APFC 414-96X96 1CT 1PH 12 STAGE-230V
APFC414-1CT-1PH-4R-AL	APFC 414-96X96 3CT 1PH 4 STAGE-230V ALARM
APFC414-1CT-1PH-6R-AL	APFC 414-96X96 3CT 1PH 6 STAGE-230V ALARM
APFC414-1CT-1PH-8R-AL	APFC 414-96X96 3CT 1PH 8 STAGE-230V ALARM
APFC414-1CT-1PH-12R-AL	APFC 414-96X96 3CT 1PH 12 STAGE-230V ALARM

PRODUCT NAME	DESCRIPTIONS
APFC414-3CT-3PH-4R	APFC 414-96X96 1CT 3PH 4 STAGE-415V
APFC414-3CT-3PH-6R	APFC 414-96X96 1CT 3PH 6 STAGE-415V
APFC414-3CT-3PH-8R	APFC 414-96X96 1CT 3PH 8 STAGE-415V
APFC414-3CT-3PH-12R	APFC 414-96X96 1CT 3PH 12 STAGE-415V
APFC414-3CT-3PH-4R-AL	APFC 414-96X96 3CT 3PH 4 STAGE-415V ALARM
APFC414-3CT-3PH-6R-AL	APFC 414-96X96 3CT 3PH 6 STAGE-415V ALARM
APFC414-3CT-3PH-8R-AL	APFC 414-96X96 3CT 3PH 8 STAGE-415V ALARM
APFC414-3CT-3PH-12R-AL	APFC 414-96X96 3CT 3PH 12 STAGE-415V ALARM

PRODUCT NAME	DESCRIPTIONS
APFC414-144-1PH-6R	APFC 414-144X144 1CT 1PH 6 STAGE-230V
APFC414-144-1PH-8R	APFC 414-144X144 1CT 1PH 8 STAGE-230V
APFC414-144-1PH-12R	APFC 414-144X144 1CT 1PH 12 STAGE-230V
APFC414-144-1PH-6R-AL	APFC 414-144X144 1CT 1PH 6 STAGE-230V ALARM
APFC414-144-1PH-8R-AL	APFC 414-144X144 1CT 1PH 8 STAGE-230V ALARM
APFC414-144-1PH-12R-AL	APFC 414-144X144 1CT 1PH 12 STAGE-230V ALARM

PRODUCT NAME	DESCRIPTIONS
APFC414-144-3PH-6R	APFC 414-144X144 1CT 3PH 6 STAGE-415V
APFC414-144-3PH-8R	APFC 414-144X144 1CT 3PH 8 STAGE-415V
APFC414-144-3PH-12R	APFC 414-144X144 1CT 3PH 12 STAGE-415V
APFC414-144-3PH-16R	APFC 414-144X144 1CT 3PH 16 STAGE-415V
APFC414-144-3PH-6R-AL	APFC 414-144X144 1CT 3PH 6 STAGE-415V-ALARM
APFC414-144-3PH-8R-AL	APFC 414-144X144 1CT 3PH 8 STAGE-415V-ALARM
APFC414-144-3PH-12R-AL	APFC 414-144X144 1CT 3PH 12 STAGE-415V-ALARM
APFC414-144-3PH-16R-AL	APFC 414-144X144 1CT 3PH 16 STAGE-415V-ALARM

PRODUCT NAME	DESCRIPTIONS
APFC-PRO-3CT-3PH-4R	APFC PRO-96X96 1CT 3PH 4 STAGE-415V
APFC-PRO-3CT-3PH-6R	APFC PRO-96X96 1CT 3PH 6 STAGE-415V
APFC-PRO-3CT-3PH-8R	APFC PRO-96X96 1CT 3PH 8 STAGE-415V
APFC-PRO-3CT-3PH-12R	APFC PRO-96X96 1CT 3PH 12 STAGE-415V

PRODUCT NAME	DESCRIPTIONS
APFC UNO-6R	APFC UNO 6 RELAY
APFC UNO-8R	APFC UNO 8 RELAY
APFC UNO-12R	APFC UNO 12 RELAY
APFC UNO-6R-EN	APFC UNO 6 RELAY ENERGY
APFC UNO-8R-EN	APFC UNO 8 RELAY ENERGY
APFC UNO-12R-EN	APFC UNO 12 RELAY ENERGY
APFC UNO-6R-RS	APFC UNO 6 RELAY Rs485
APFC UNO-8R-RS	APFC UNO 8 RELAY Rs485
APFC UNO-12R-RS	APFC UNO 12 RELAY Rs485
APFC UNO-6R-EN-RS	APFC UNO 6 RELAY ENERGY Rs485
APFC UNO-8R-EN-RS	APFC UNO 8 RELAY ENERGY Rs485
APFC UNO-12R-EN-RS	APFC UNO 12 RELAY ENERGY Rs485

6 Relay- 1 Alarm Output Std

8 Relay & 12 Relay- 2 Alarm Output Std

PRODUCT NAME	DESCRIPTIONS
APFC36L-144-6R	APFC 3CT-144X144 LCD 6 STAGE
APFC36L-144-8R	APFC 3CT-144X144 LCD 8 STAGE
APFC36L-144-12R	APFC 3CT-144X144 LCD 12 STAGE
APFC36L-144-16R	APFC 3CT-144X144 LCD 16 STAGE
APFC36L-144-6R-RS	APFC 3CT-144X144 LCD 6 STAGE- Rs485
APFC36L-144-8R-RS	APFC 3CT-144X144 LCD 8 STAGE- Rs485
APFC36L-144-12R-RS	APFC 3CT-144X144 LCD 12 STAGE- Rs485
APFC36L-144-16R-RS	APFC 3CT-144X144 LCD 16 STAGE- Rs485

Note: All New Products are available after 1st quarter 2023

PROTECTION RELAYS

LINE MONITORING RELAY	
PRODUCT NAME	SUPPLY VOLTAGE
900UVR	415V AC
903UVR	415V AC
300LMR	170V-290V AC (L-L)
500PSR	154V-520V AC (L-L)

VOLTAGE MONITORING RELAY	
PRODUCT NAME	SUPPLY VOLTAGE
300VPR-1	Self powered (310V- 520V AC (L-L))
300VPR	160V-280V AC 50/60Hz
600VPR	160V-280V AC 50/60Hz

CURRENT MONITORING RELAY	
PRODUCT NAME	SUPPLY VOLTAGE
300CPR-1	85V-270V AC/DC
300CPR	160V-270V AC (50/60Hz)
600CPR	160V-270V AC (50/60Hz)

EARTH LEAKAGE RELAY	
PRODUCT NAME	SUPPLY VOLTAGE
ELR-96	230V AC +/-20% (50/60 Hz)
ELR DIN	230V AC +/-20% (50/60 Hz)

NIPPEN

driven by values

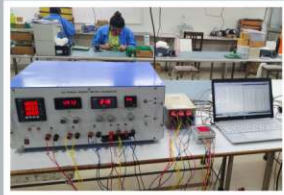

CE



Towards The Growth

LOGO

OLD



Reliable Performance



NEW

NIPPEN

driven by values

NIPPEN ELECTRICAL INSTRUMENTS CO.

106 New Tejpal Industrial Premises, Andheri-Kurla Road, Sakinaka,
Mumbai- 400 072, Maharashtra, INDIA.

Registered Office: 12-A, Joy Engg. Compound, Marol Maroshi Road, Andheri (E),
Mumbai - 400 059, Maharashtra, INDIA

Tel: 022-2920 5181/ 2925 3164/ 2920 1806

E-mail: info@nippenco.com, Customer Care: +919324243053

Visit us at: nippen.in Sales Representative: Delhi, Ahmedabad, Chennai